

Finite Automata

Part Two

Recap from Last Time

Formal Language Theory

- An **alphabet** is a set, usually denoted Σ , consisting of elements called **characters**.
- A **string over Σ** is a finite sequence of zero or more characters taken from Σ .
- The **empty string** has no characters and is denoted ε .
- A **language over Σ** is a set of strings over Σ .
- The language Σ^* is the set of all strings over Σ .

DFAs

- A ***DFA*** is a
 - ***D***eterministic
 - ***F***inite
 - ***A***utomaton
- DFAs are the simplest type of automaton that we will see in this course.

DFAs

- A DFA consists of:
 - A set of states
 - Exactly one element of the set of states designated as a start state
 - (as a consequence, the set of states must be nonempty)
 - A subset of the states designated as accepting states
 - An alphabet Σ
 - A transition function that maps (state, character) ordered pairs to states
 - (i.e., for each state in the DFA, there must be *exactly one* transition defined for each symbol in Σ)

The Language of an Automaton

- If D is a DFA that processes strings over Σ , the **language of D** , denoted $\mathcal{L}(D)$, is the set of all strings D accepts.
- Formally:

$$\mathcal{L}(D) = \{ w \in \Sigma^* \mid D \text{ accepts } w \}$$

New Stuff!

Table Representation of DFAs

Tabular DFAs

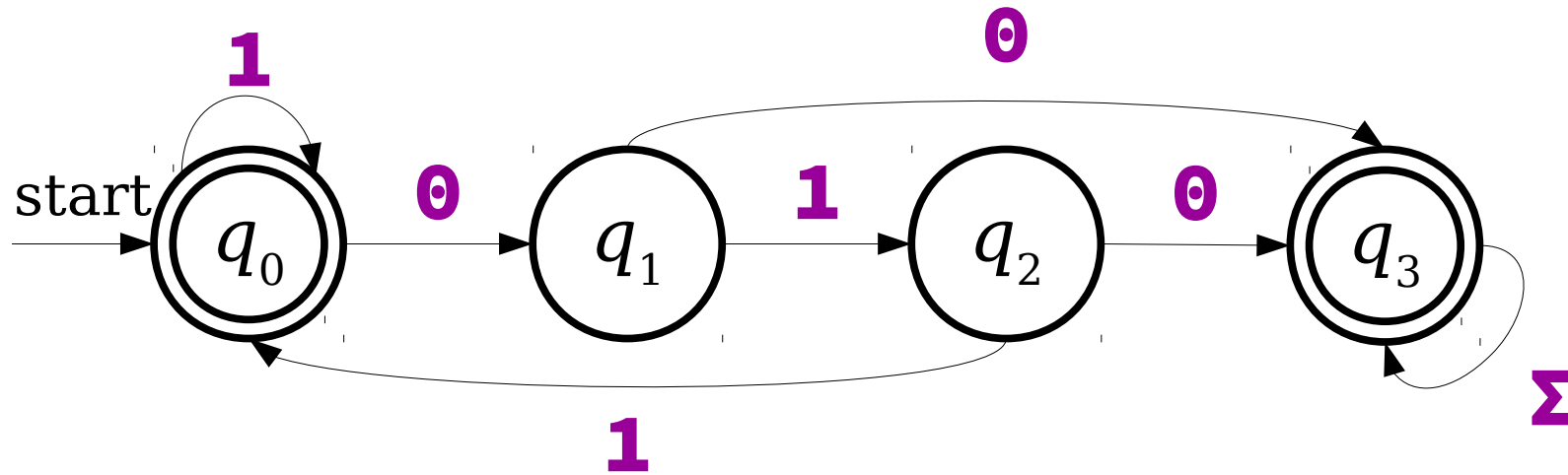

	0	1
q_0		
q_1		
q_2		
q_3		

Tabular DFAs

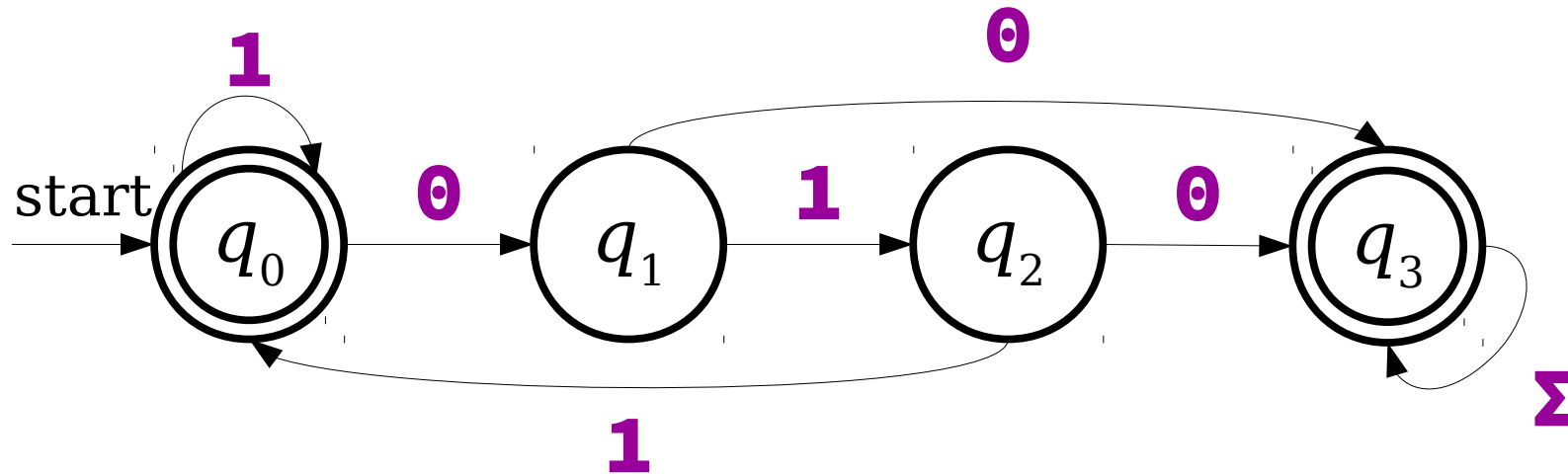

Since this is the first row, it's the start state.

	0	1
q_0	q_1	q_0
q_1		
q_2		
q_3		

Tabular DFAs

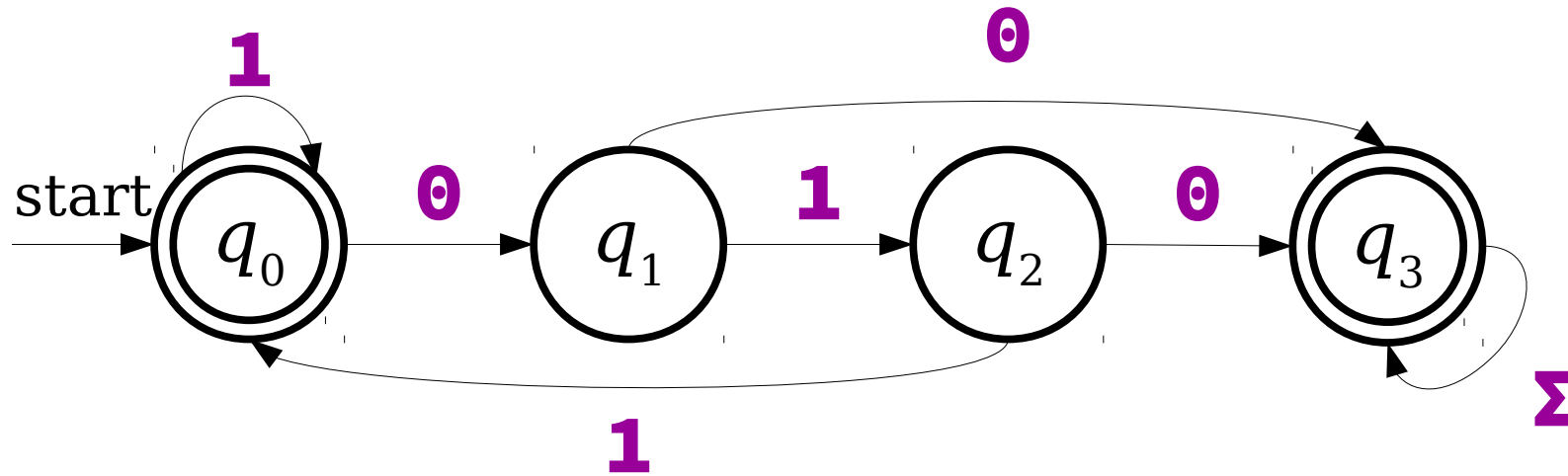

Question:
What goes in the q_1
row of the table?

	0	1
q_0	q_1	q_0
q_1		
q_2		
q_3		

Tabular DFAs

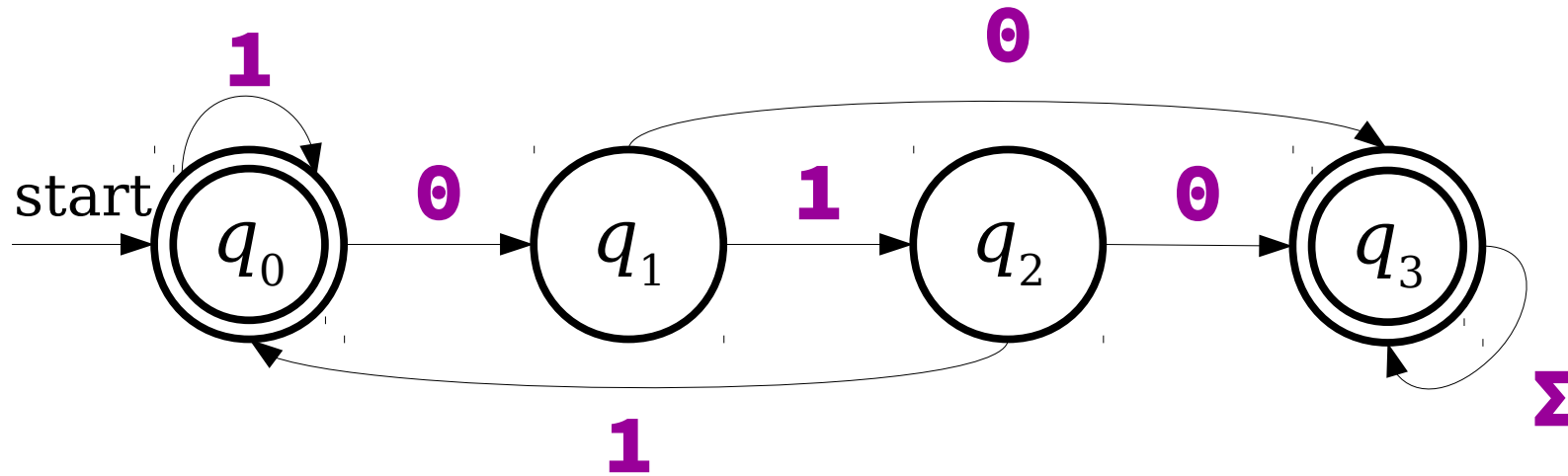

	0	1
q_0	q_1	q_0
q_1	q_3	q_2
q_2	q_3	q_0
q_3		

Tabular DFAs

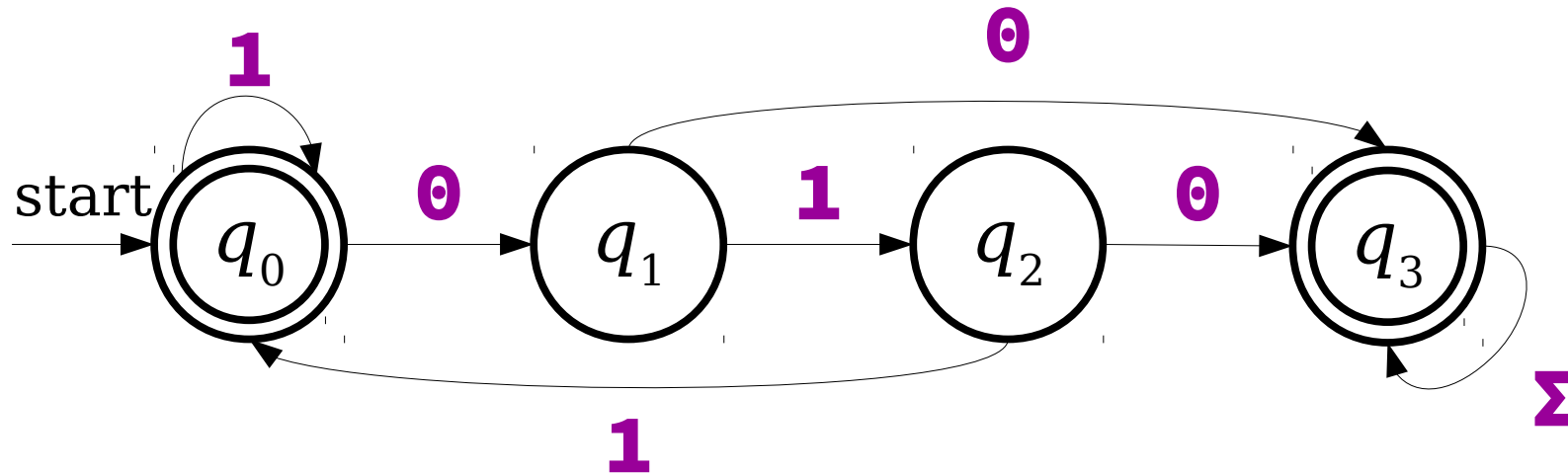

Question:
How should we complete the table?

(A)

	0	1	Σ
q_0	q_1	q_0	-
q_1	q_3	q_2	-
q_2	q_3	q_0	-
q_3	-	-	q_3

(B)

	0	1
q_0	q_1	q_0
q_1	q_3	q_2
q_2	q_3	q_0
q_3	q_3	q_3

Tabular DFAs

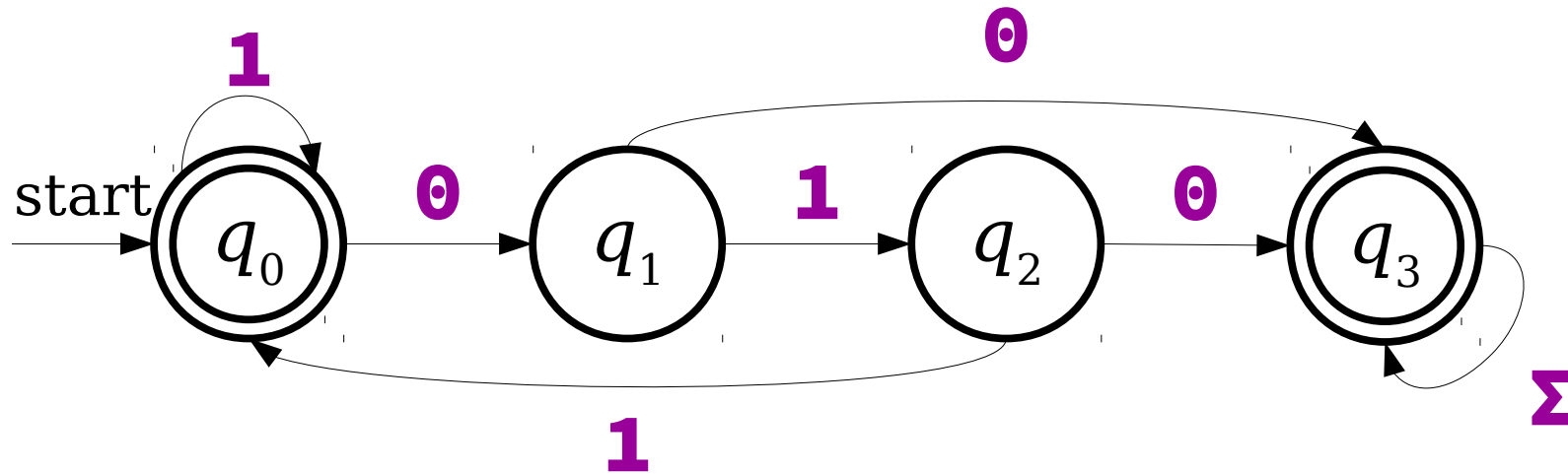

	0	1
q_0	q_1	q_0
q_1	q_3	q_2
q_2	q_3	q_0
q_3	q_3	q_3

Tabular DFAs

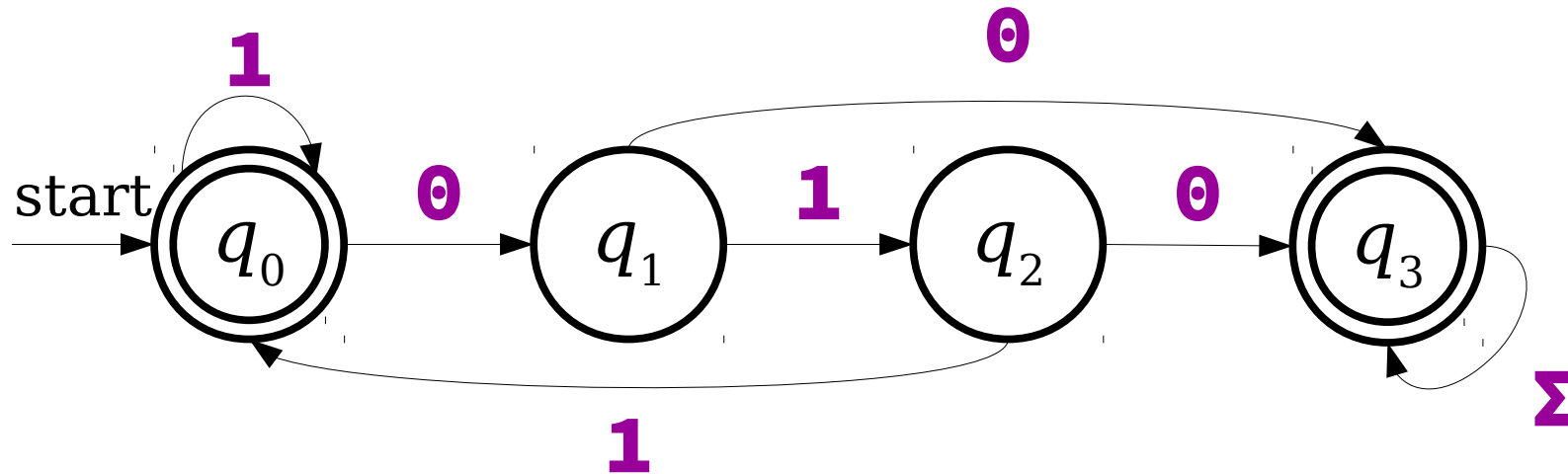

These stars indicate accepting states.

	0	1
* q_0	q_1	q_0
q_1	q_3	q_2
q_2	q_3	q_0
* q_3	q_3	q_3

Tabular DFAs

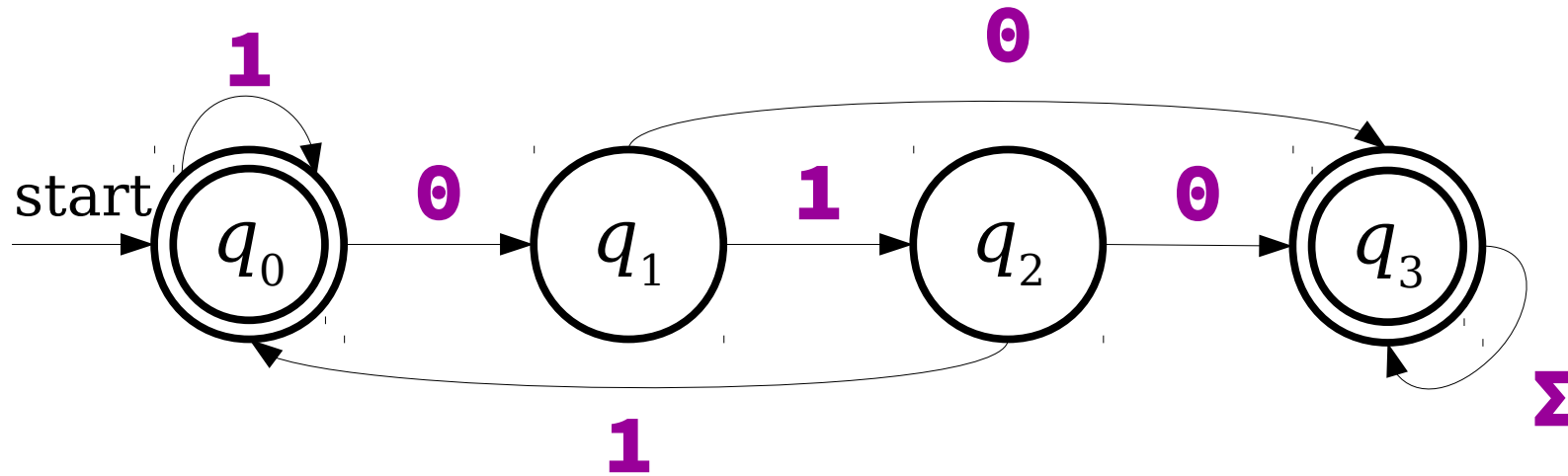

	0	1
* q_0	q_1	q_0
q_1	q_3	q_2
q_2	q_3	q_0
* q_3	q_3	q_3

The Regular Languages

A language L is called a ***regular language*** if there exists a DFA D such that $\mathcal{L}(D) = L$.

If L is a language and $\mathcal{L}(D) = L$, we say that D ***recognizes*** the language L .

The Complement of a Language

- Given a language $L \subseteq \Sigma^*$, the **complement** of that language (denoted \bar{L}) is the language of all strings in Σ^* that aren't in L .
- Formally:

$$\bar{L} = \Sigma^* - L$$

The Complement of a Language

- Given a language $L \subseteq \Sigma^*$, the **complement** of that language (denoted \bar{L}) is the language of all strings in Σ^* that aren't in L .
- Formally:

$$\bar{L} = \Sigma^* - L$$



The Complement of a Language

- Given a language $L \subseteq \Sigma^*$, the **complement** of that language (denoted \bar{L}) is the language of all strings in Σ^* that aren't in L .
- Formally:

$$\bar{L} = \Sigma^* - L$$

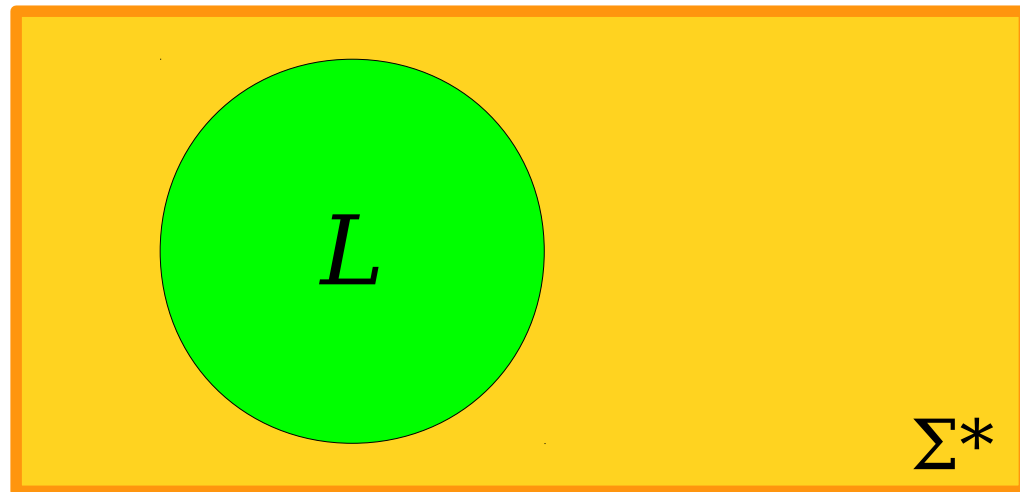

The Complement of a Language

- Given a language $L \subseteq \Sigma^*$, the **complement** of that language (denoted \bar{L}) is the language of all strings in Σ^* that aren't in L .
- Formally:

$$\bar{L} = \Sigma^* - L$$

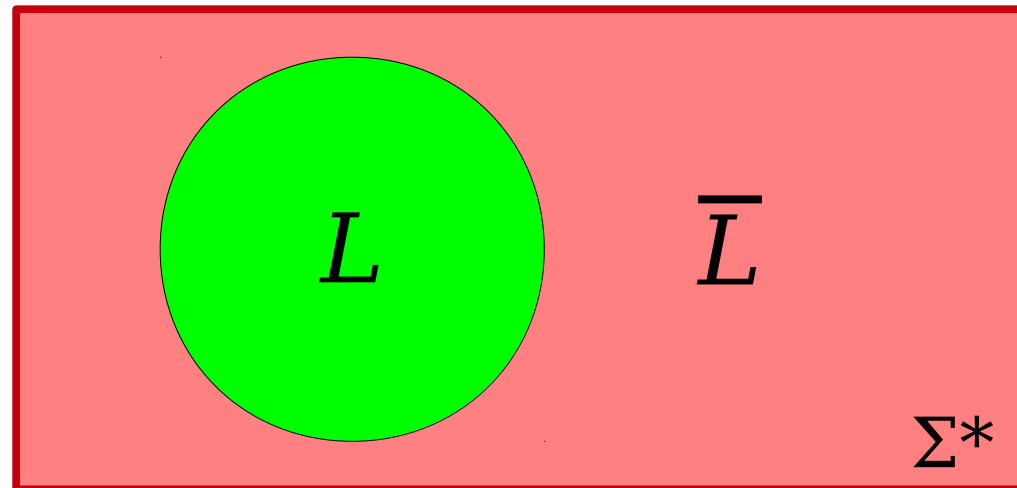

Complementing Regular Languages

$$L = \{ w \in \{a, b\}^* \mid w \text{ contains } \mathbf{aa} \text{ as a substring} \}$$

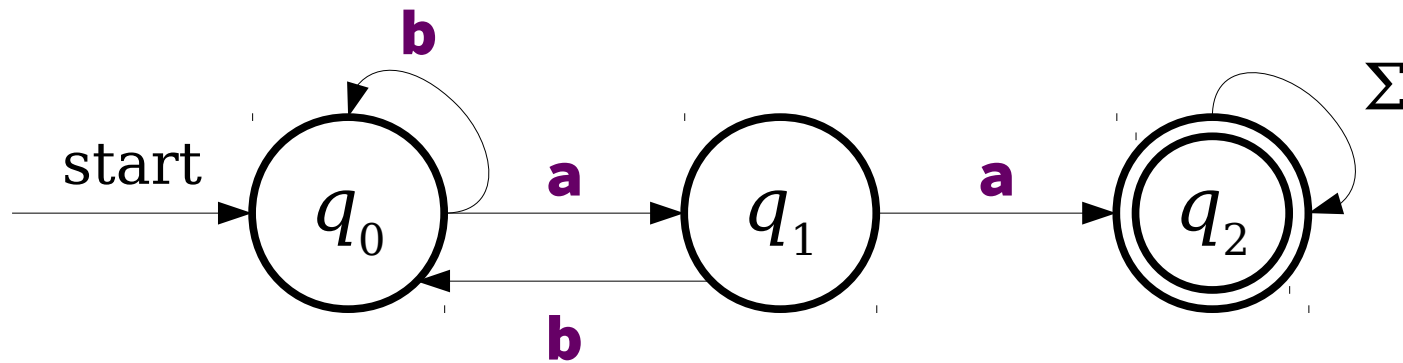

$$\bar{L} = \{ w \in \{a, b\}^* \mid w \text{ *does not* contain } \mathbf{aa} \text{ as a substring} \}$$

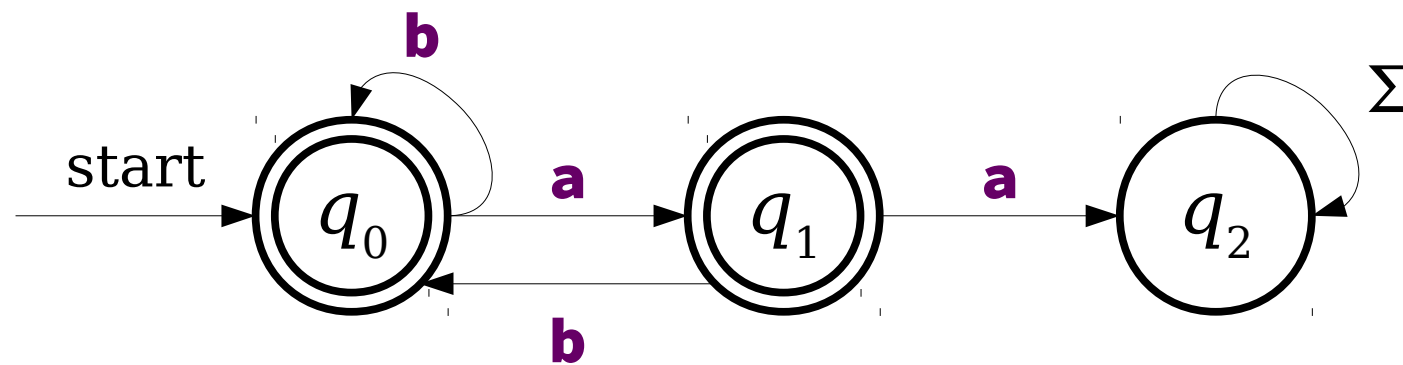

Closure Properties

- **Theorem:** If L is a regular language, then \bar{L} is also a regular language.
- (We haven't formally proved this, but you may assume it's true in this class.)
- As a result, we say that the regular languages are **closed under complementation**.

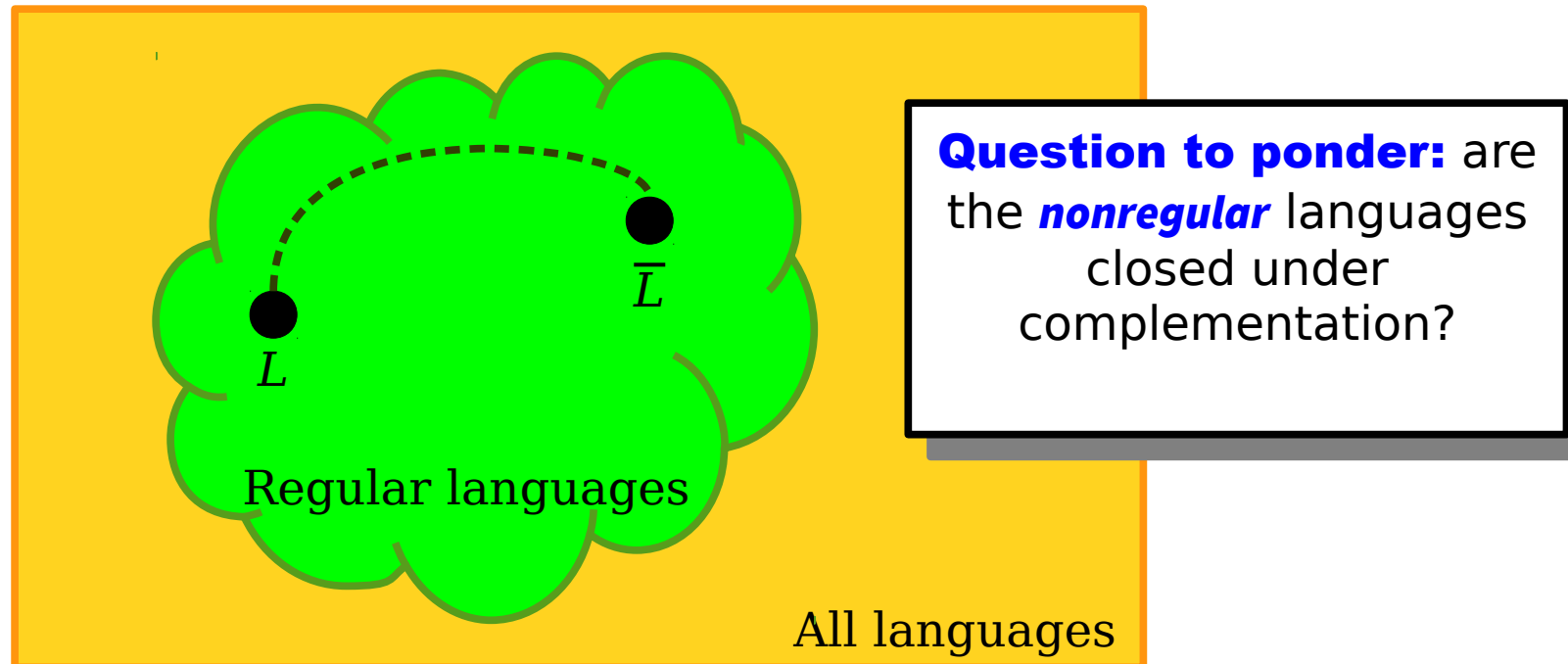

NFAS

Revisiting a Problem

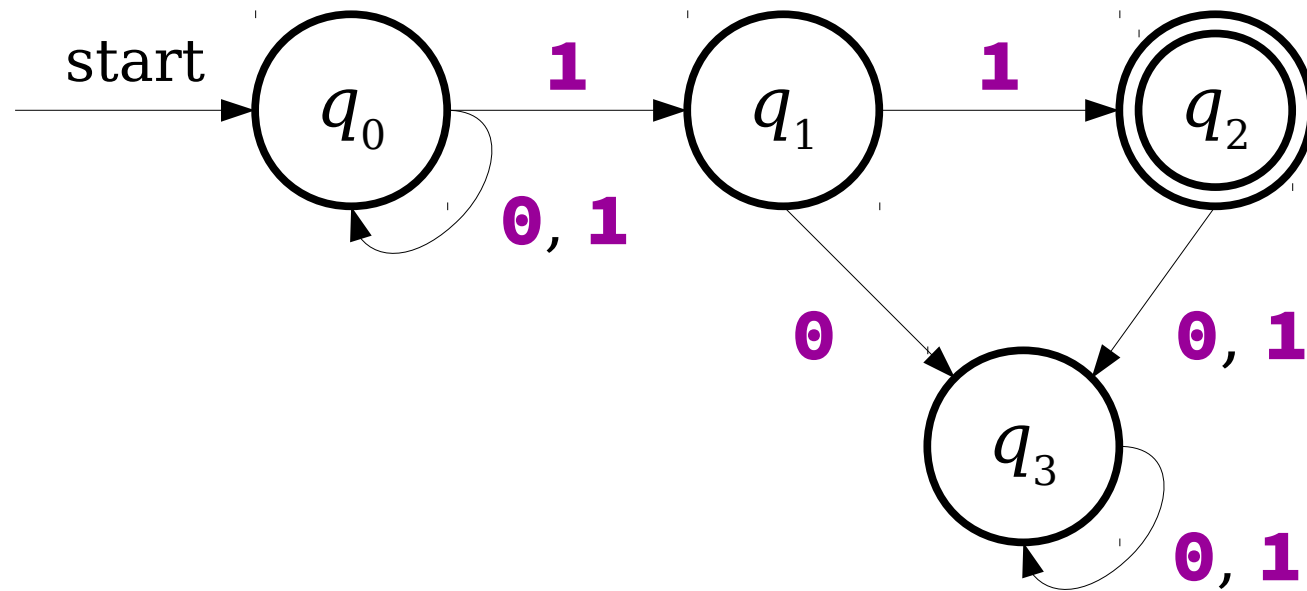

NFAs

- An **NFA** is a
 - **N**ondeterministic
 - **F**inite
 - **A**utomaton
- A model of computation is **nondeterministic** if the computing machine has a finite number of choices available to make at each point, possibly including zero.
- Represents a fundamental shift in how we'll think about computation.

NFA

- State structure similar to a DFA
- Different transition function:
 - DFA: $\delta : (S \times \Sigma) \rightarrow S$
 - *always go to exactly one state*
 - NFA: $\delta : (S \times \Sigma) \rightarrow \wp(S)$
 - *could go to one, many, or none!*
- Different accept condition:
 - Accepts if ***there exists*** a series of choices that ends in an accepting state.

A Simple NFA

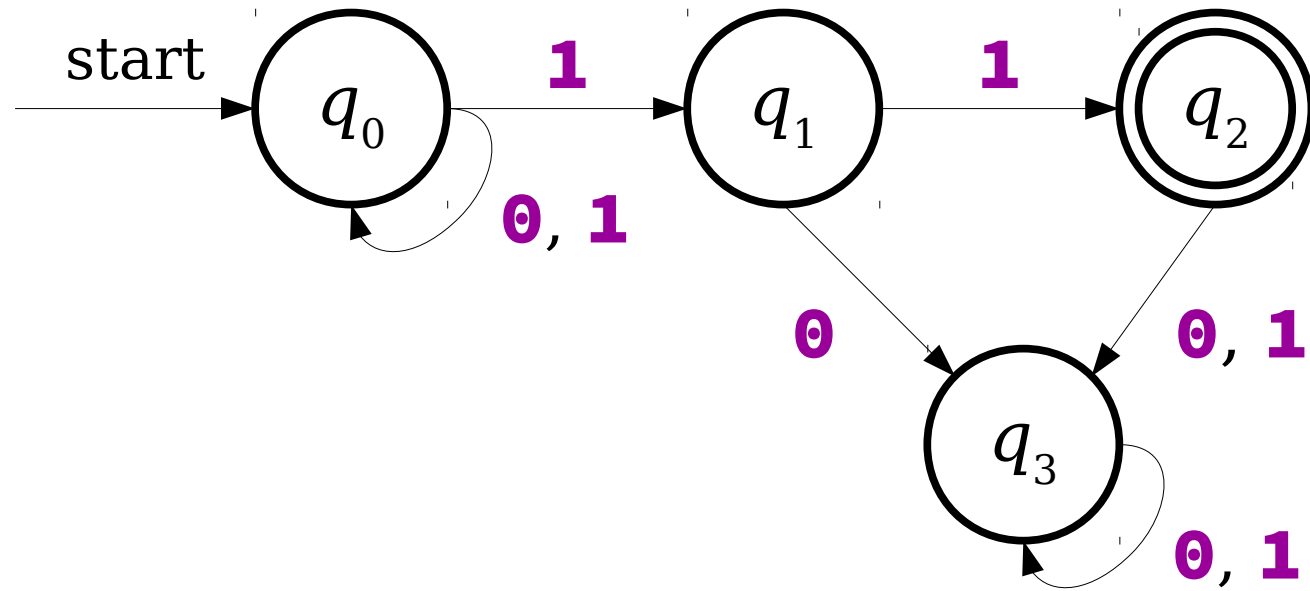

A Simple NFA

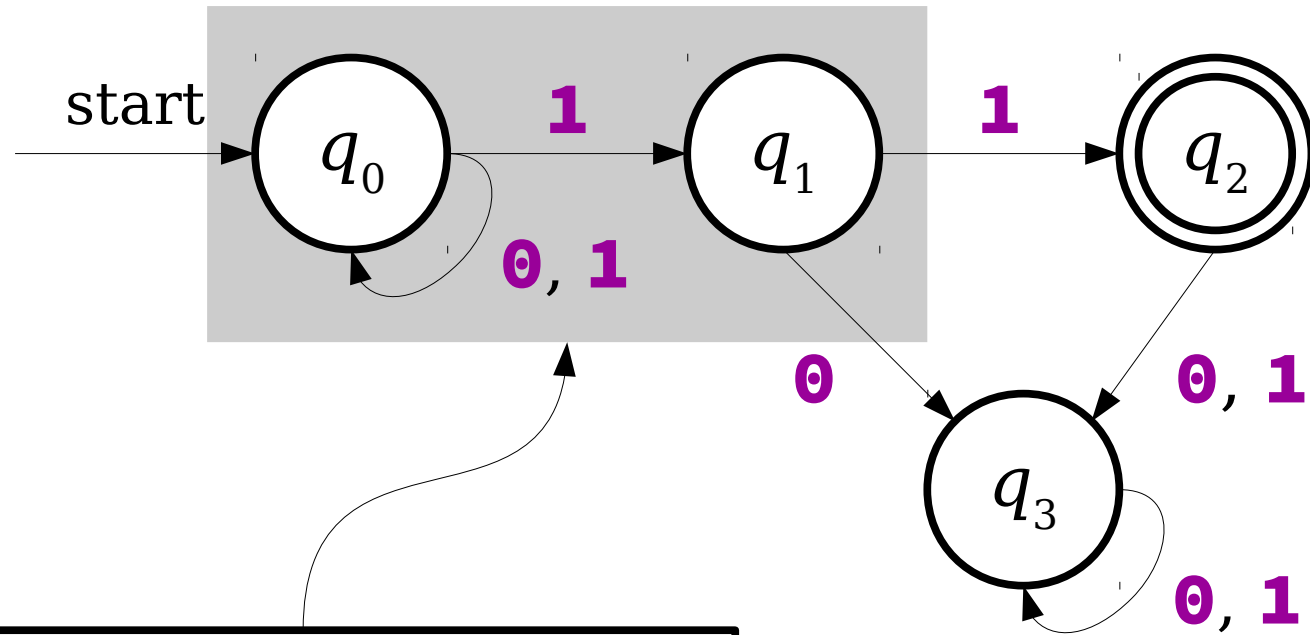

q_0 has two transitions defined on 1!

A Simple NFA

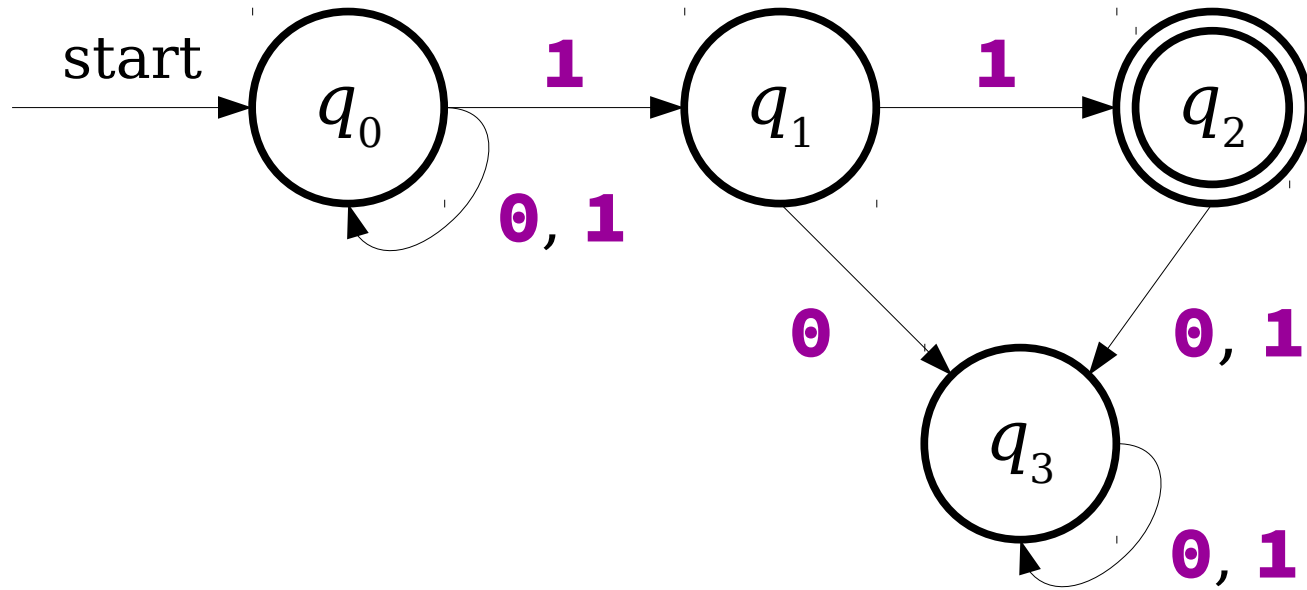

0	1	0	1	1
----------	----------	----------	----------	----------

A Simple NFA

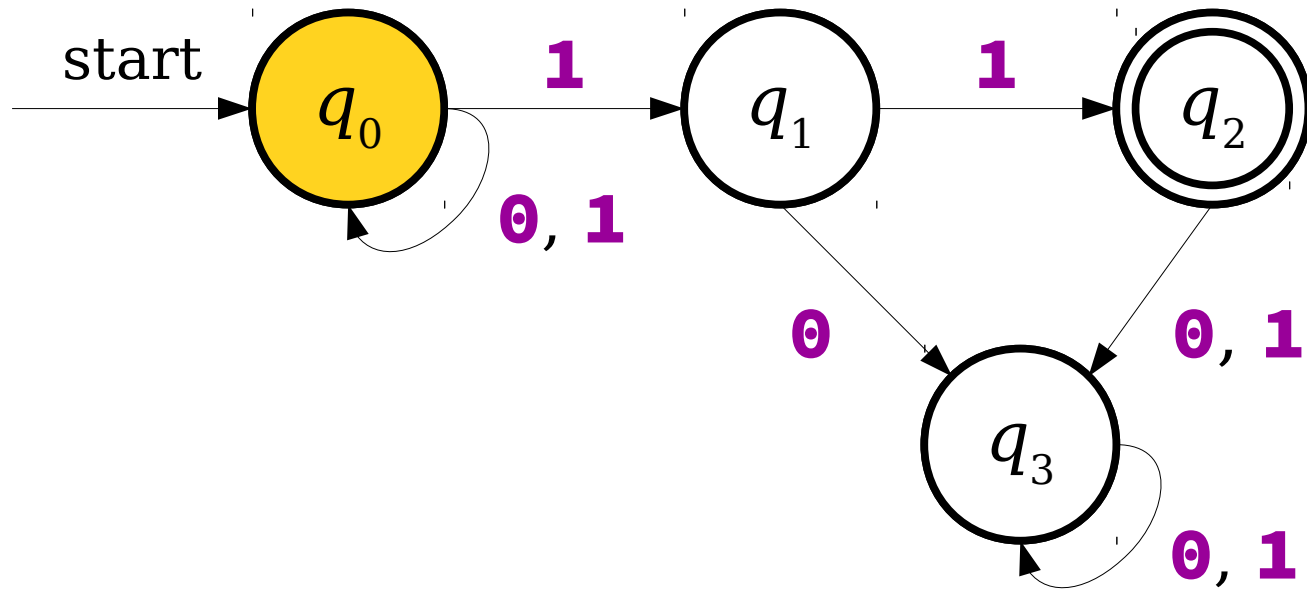

0	1	0	1	1
----------	----------	----------	----------	----------

A Simple NFA

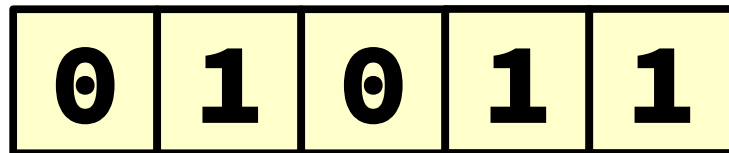
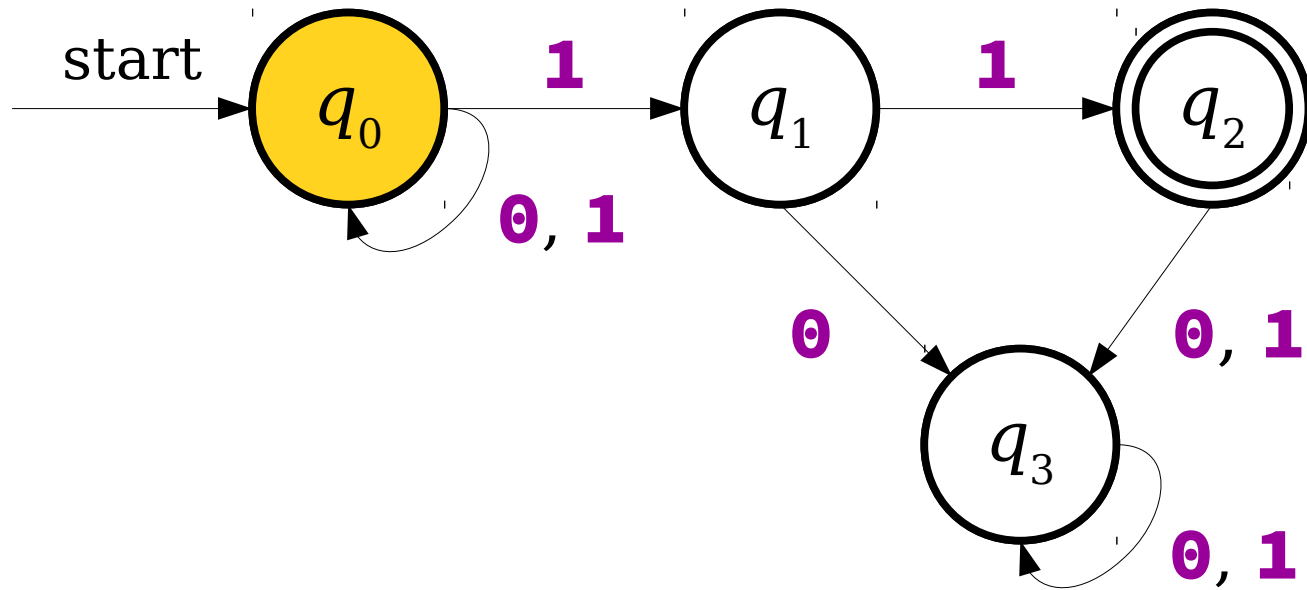

A Simple NFA

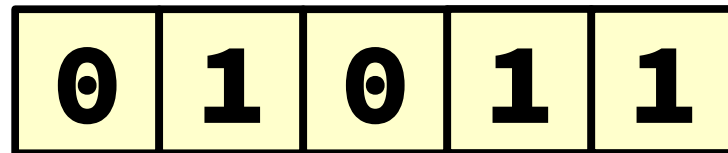
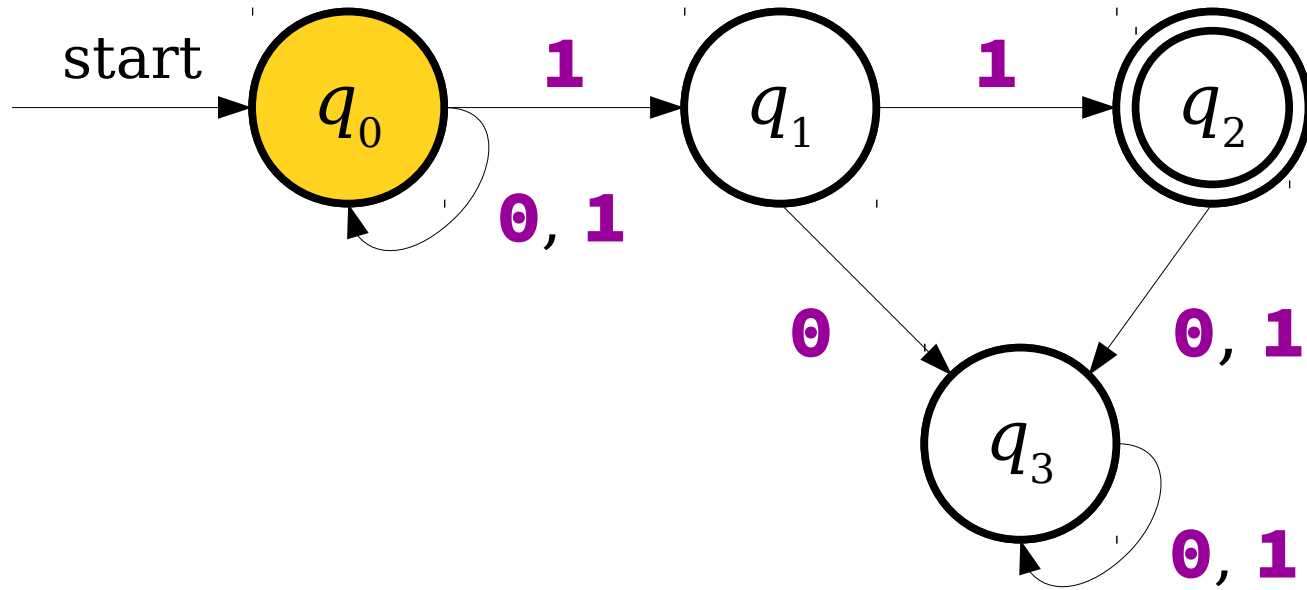

A Simple NFA

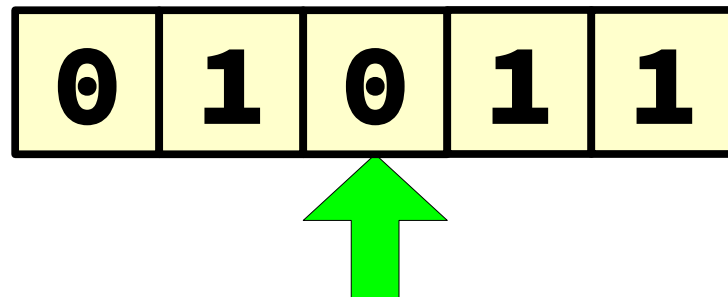
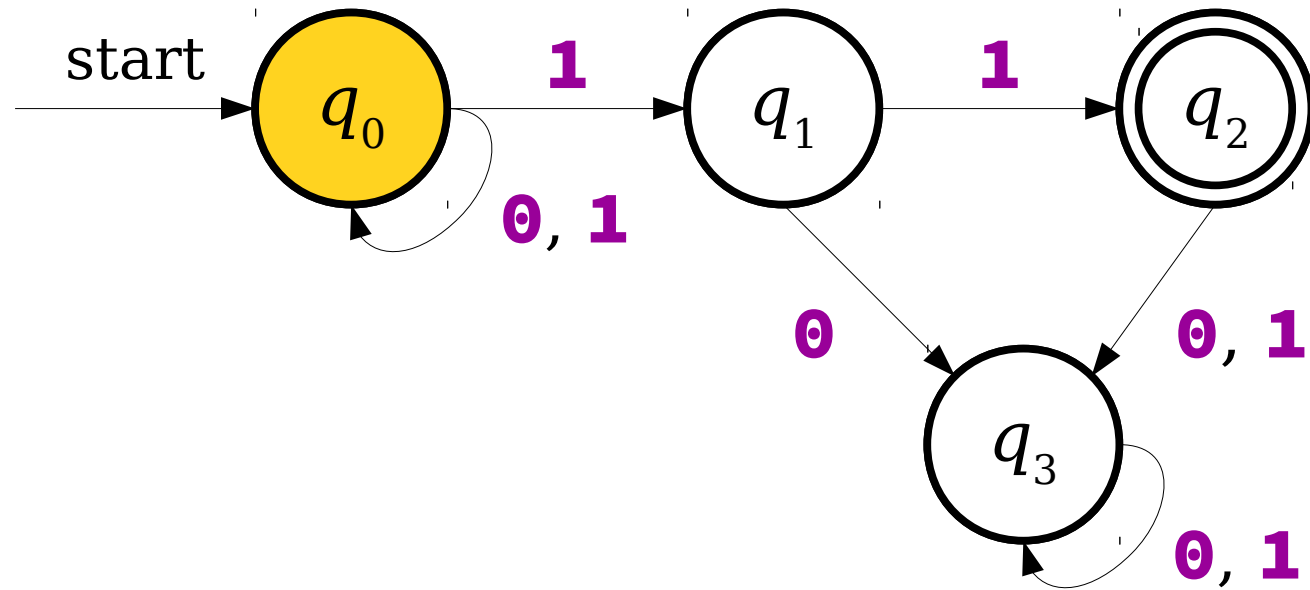

A Simple NFA

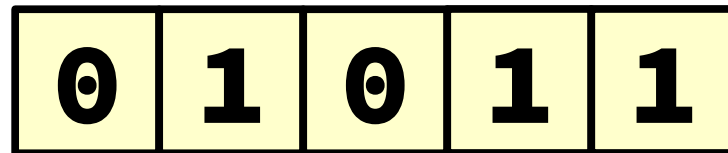
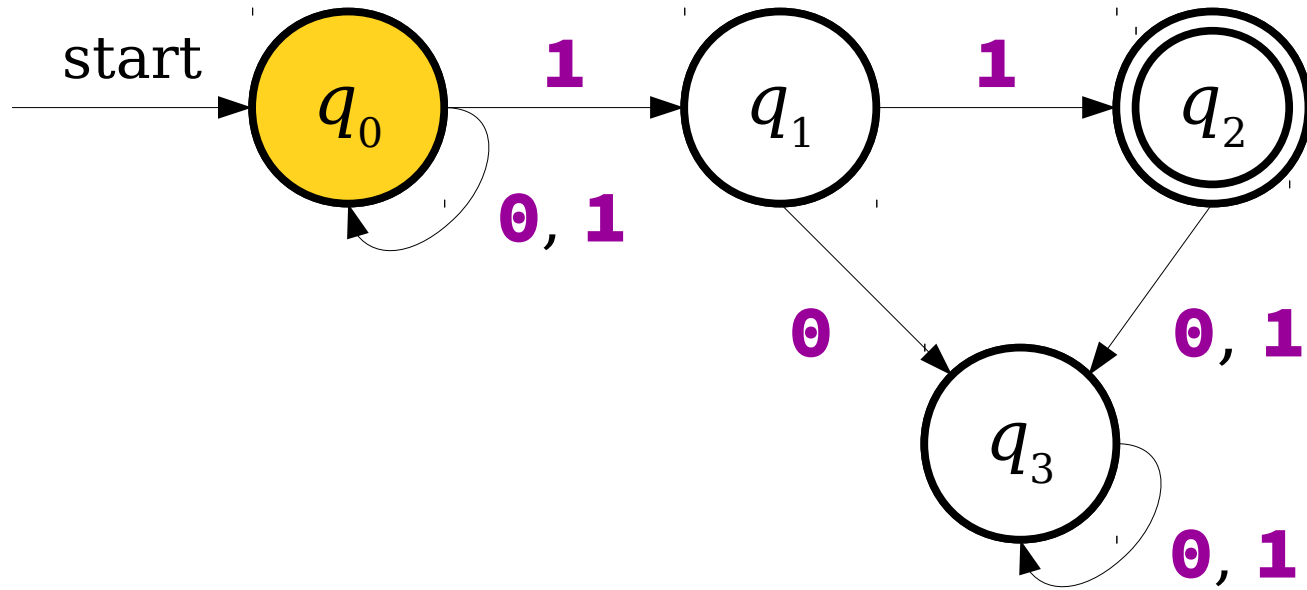

A Simple NFA

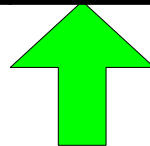
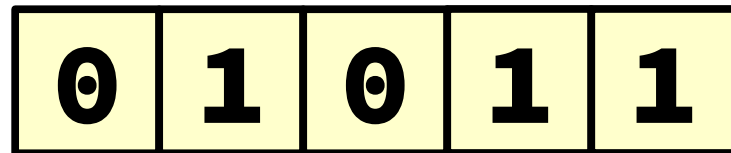
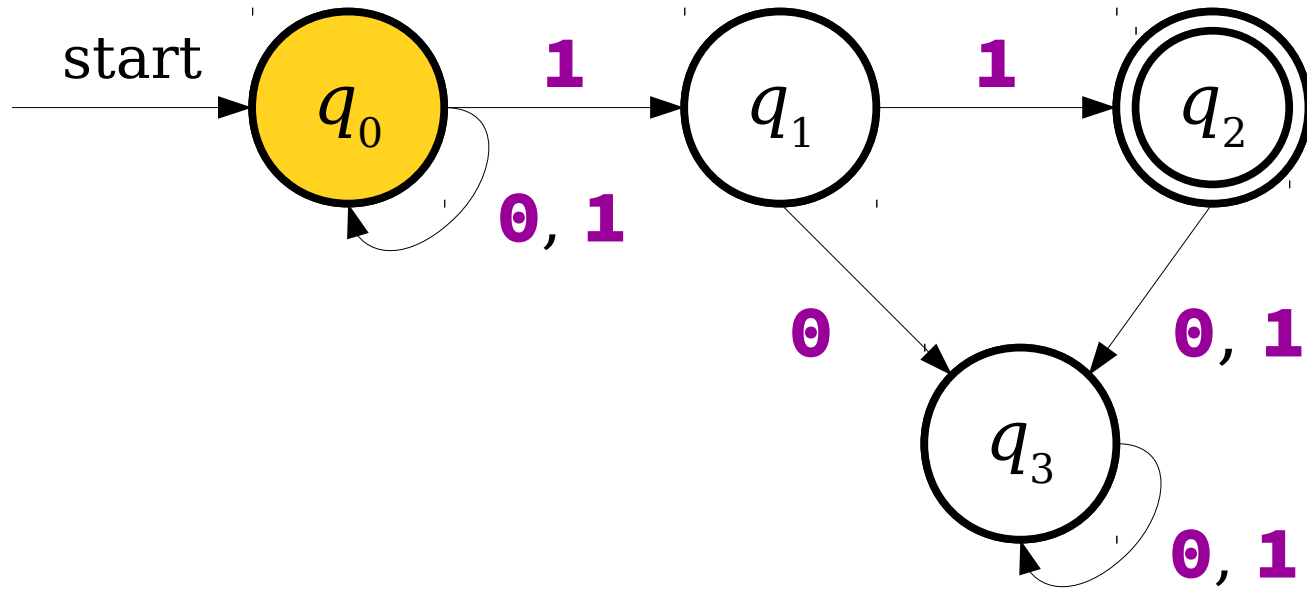

A Simple NFA

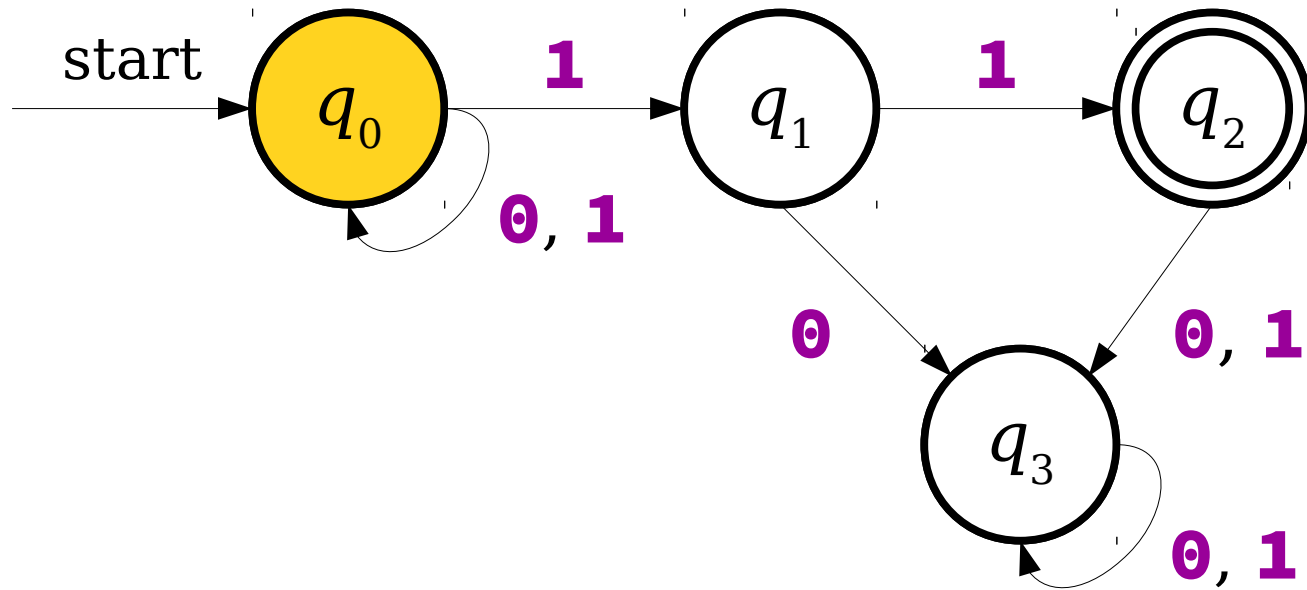

0	1	0	1	1
----------	----------	----------	----------	----------

A Simple NFA

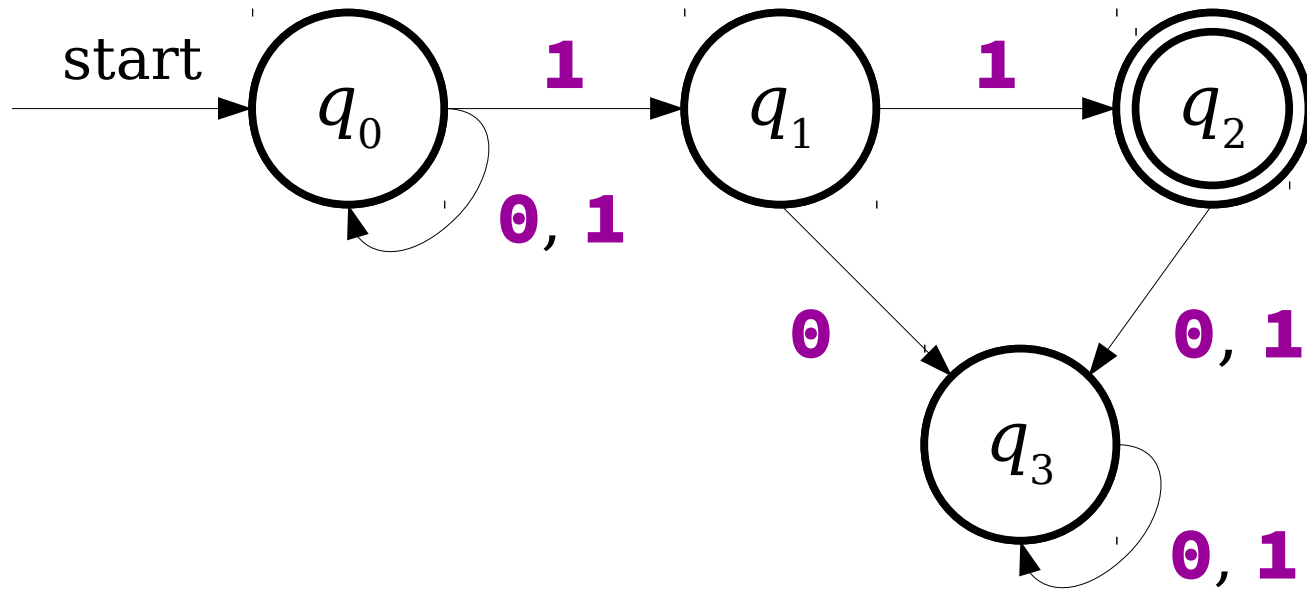

0	1	0	1	1
----------	----------	----------	----------	----------

A Simple NFA

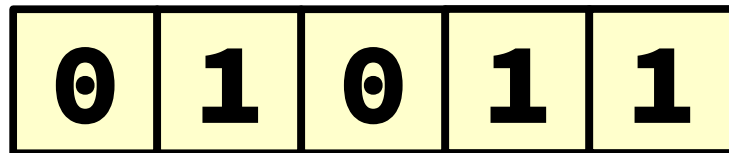
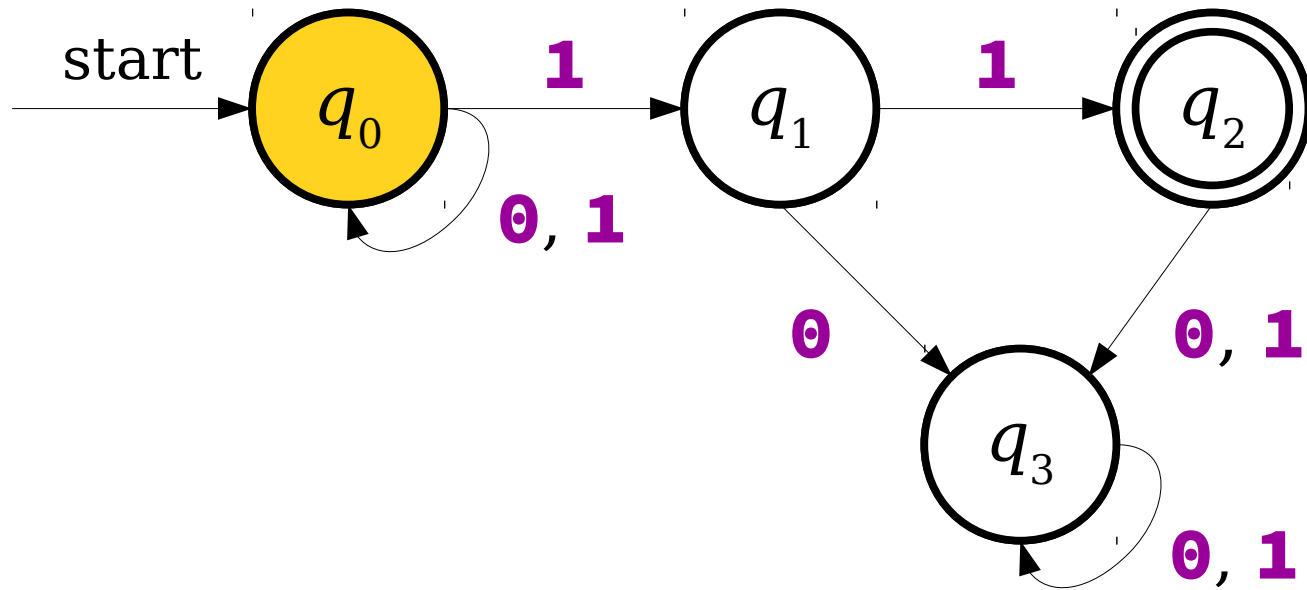

A Simple NFA

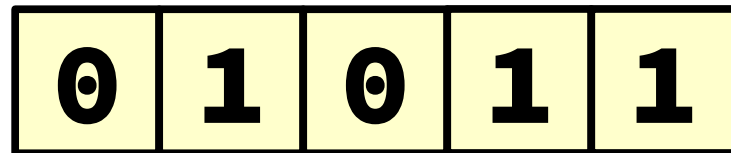
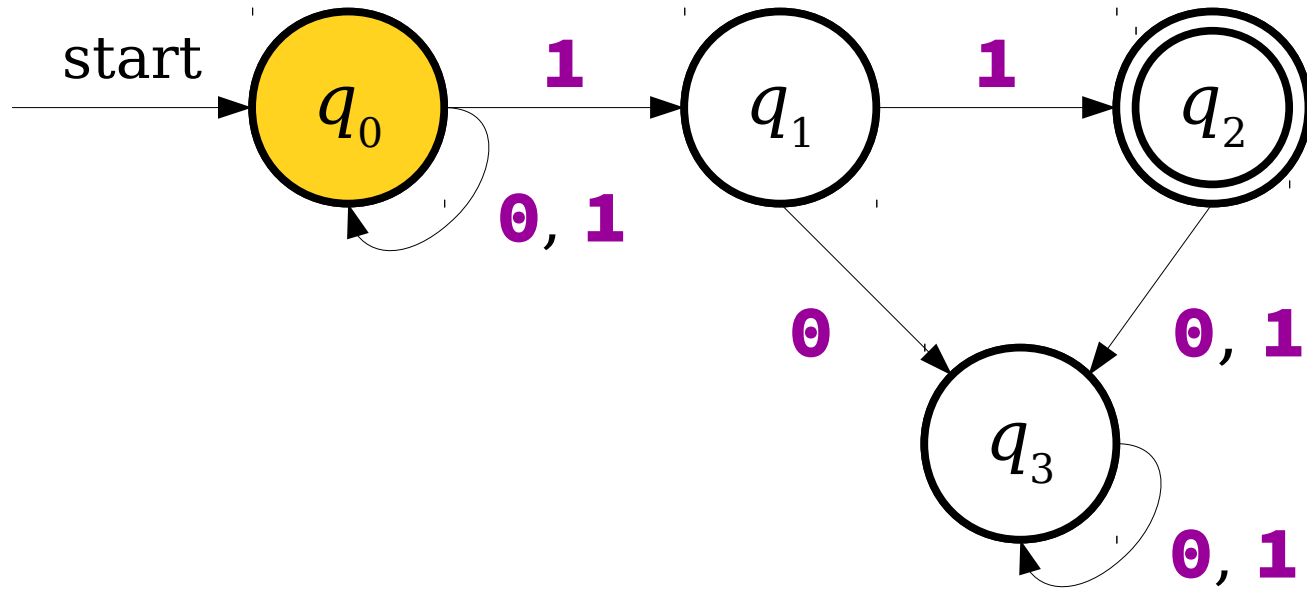

A Simple NFA

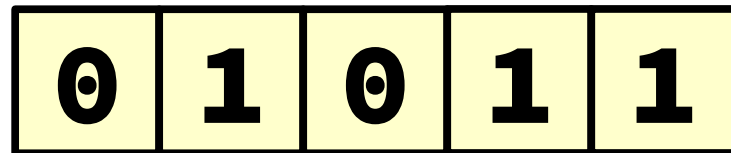
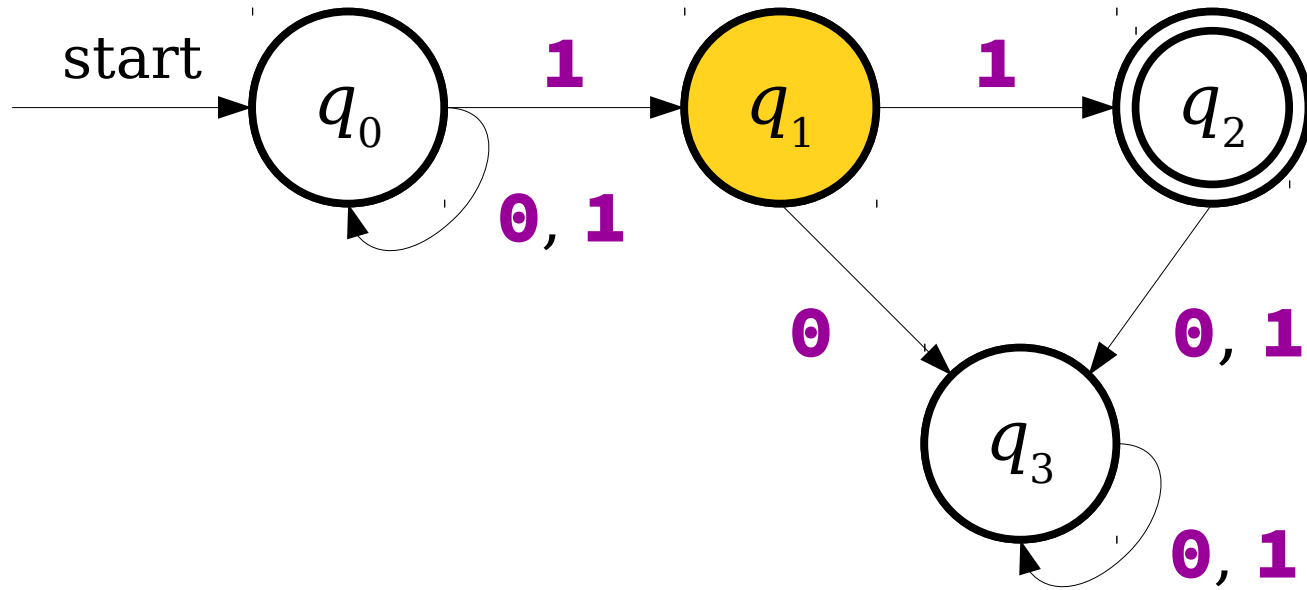

A Simple NFA

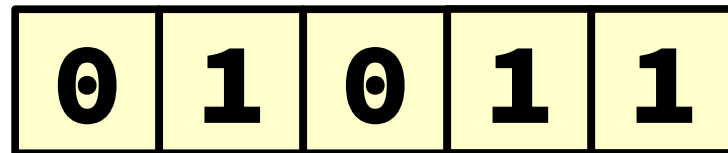
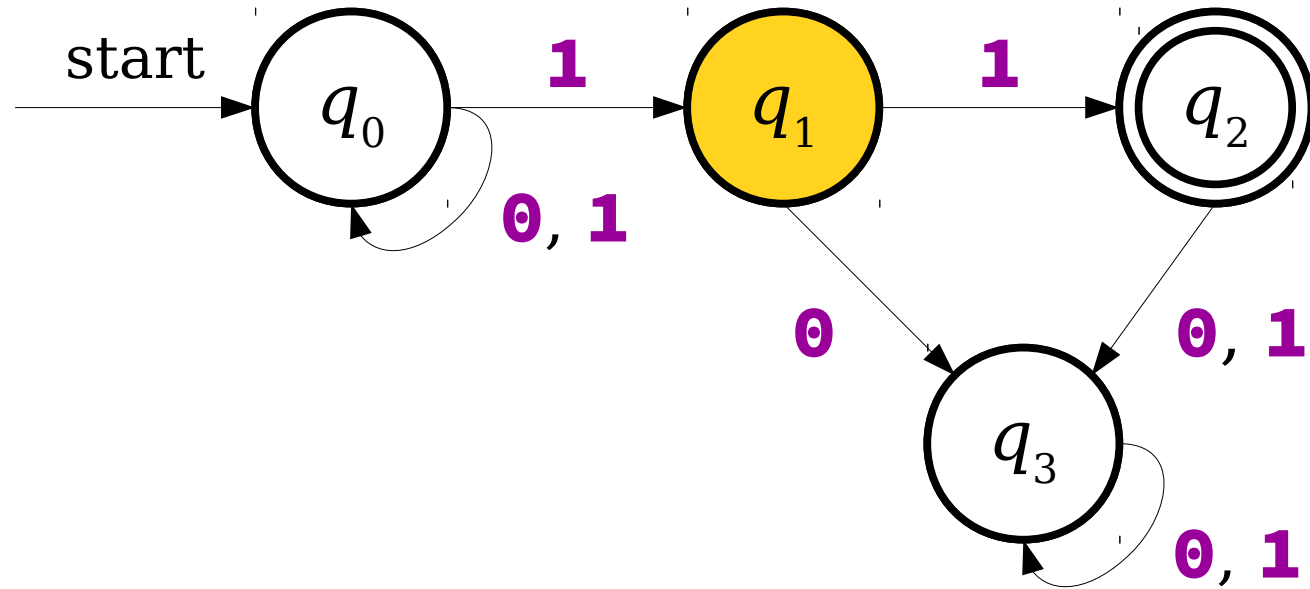

A Simple NFA

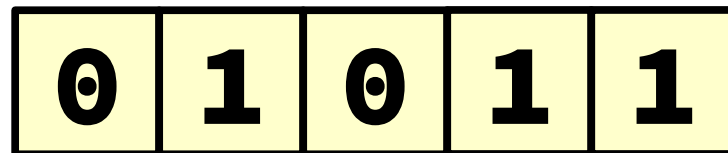
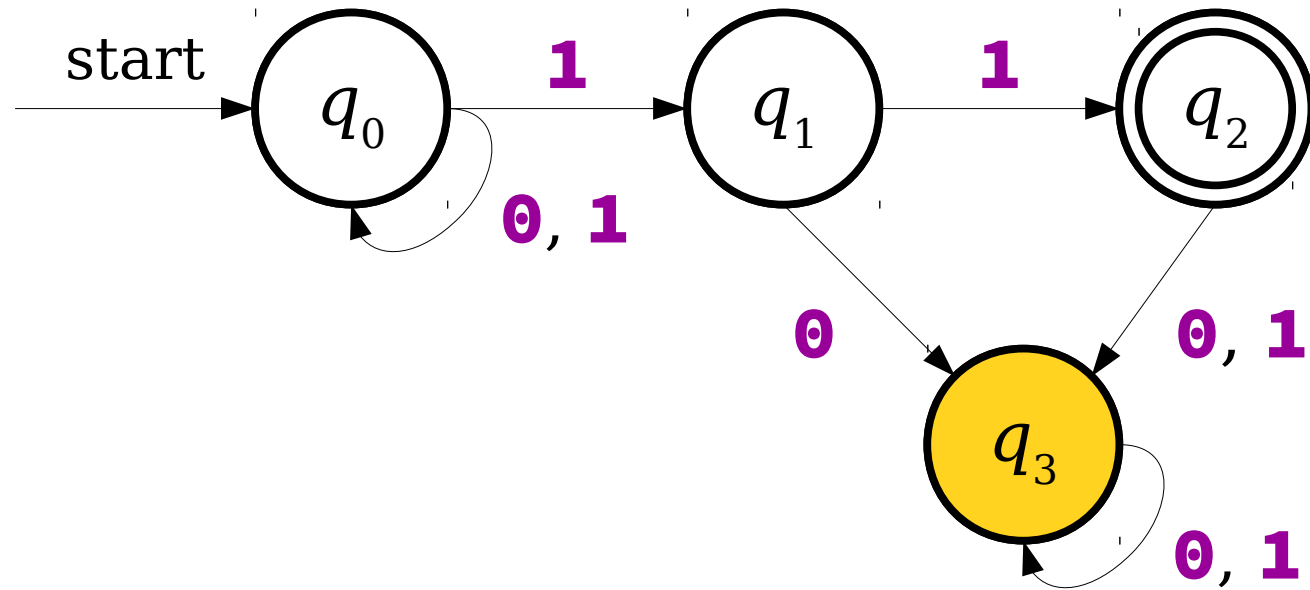

A Simple NFA

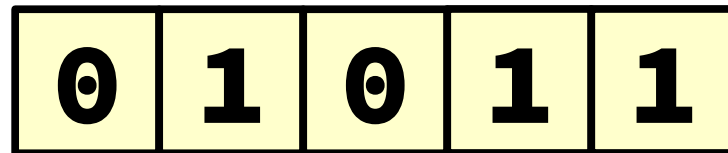
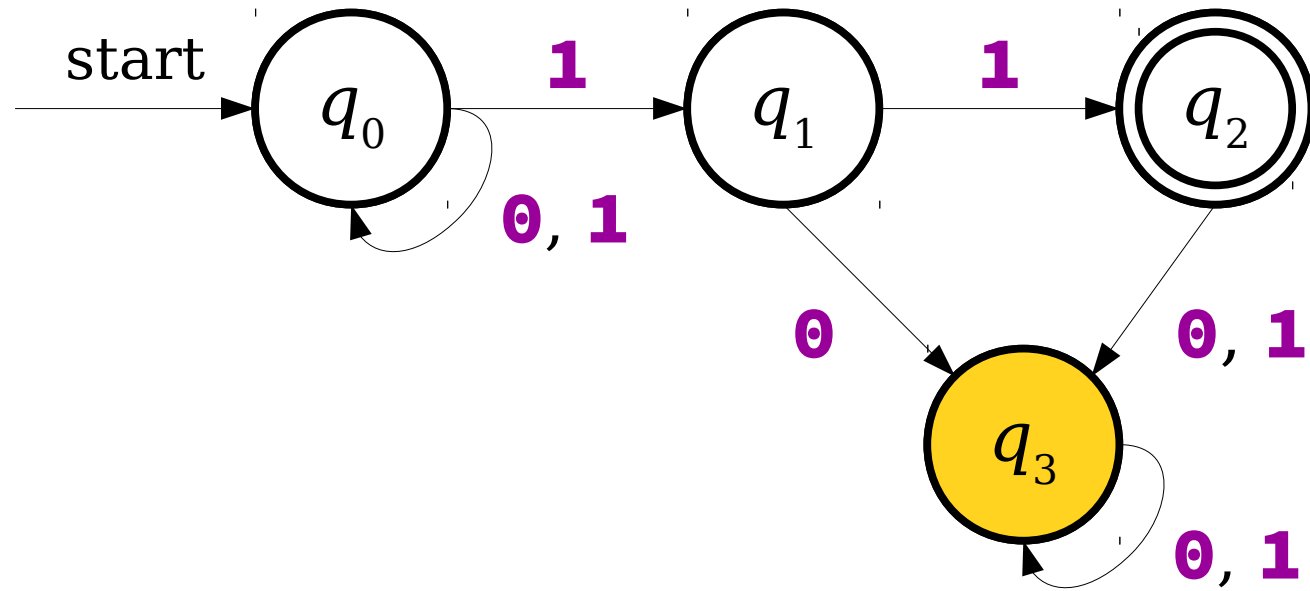

A Simple NFA

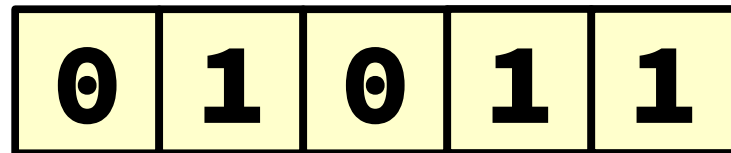
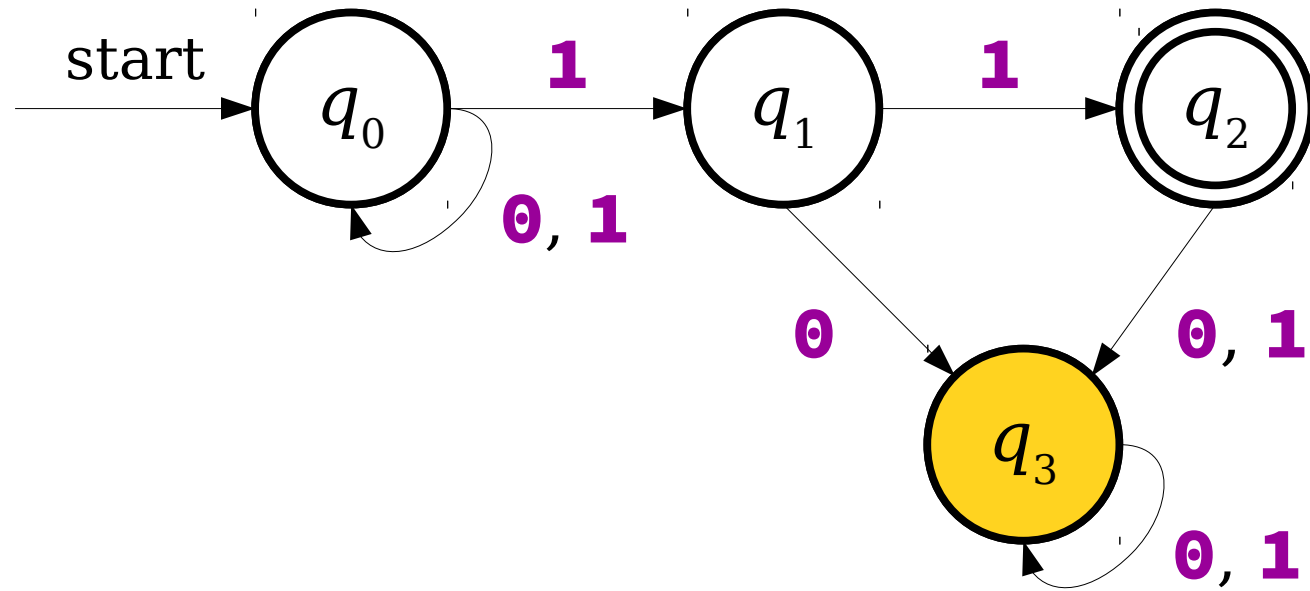

A Simple NFA

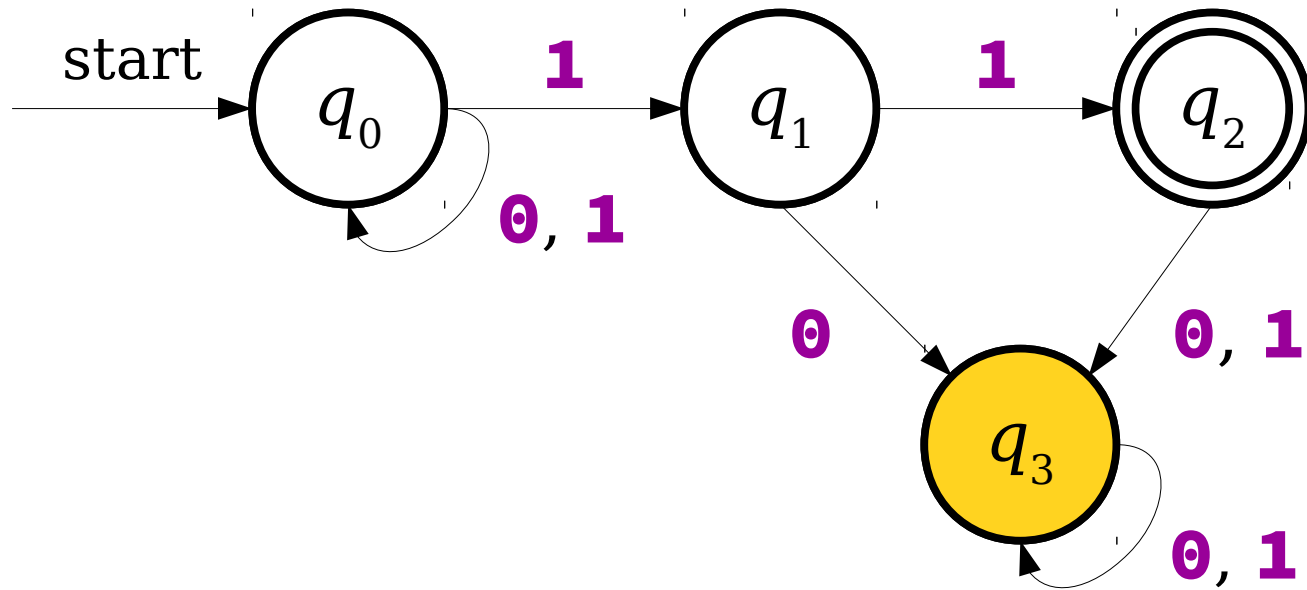

0	1	0	1	1
----------	----------	----------	----------	----------

A Simple NFA

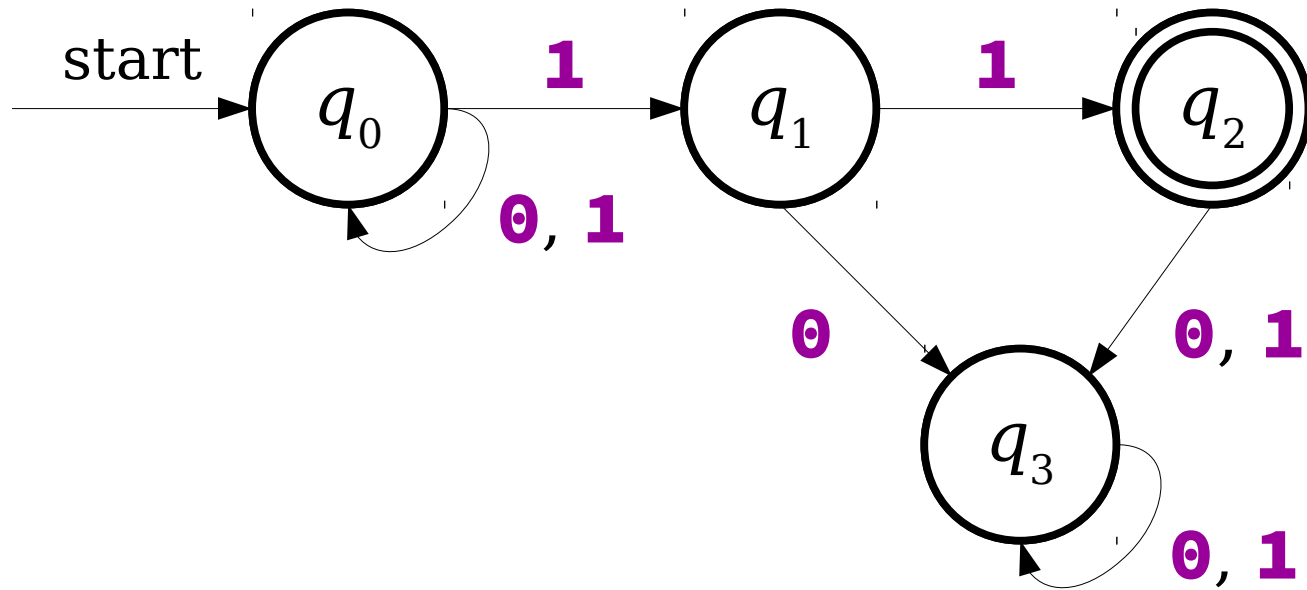

0	1	0	1	1
----------	----------	----------	----------	----------

A Simple NFA

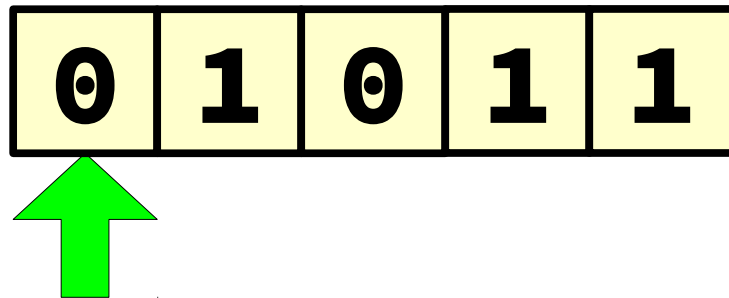
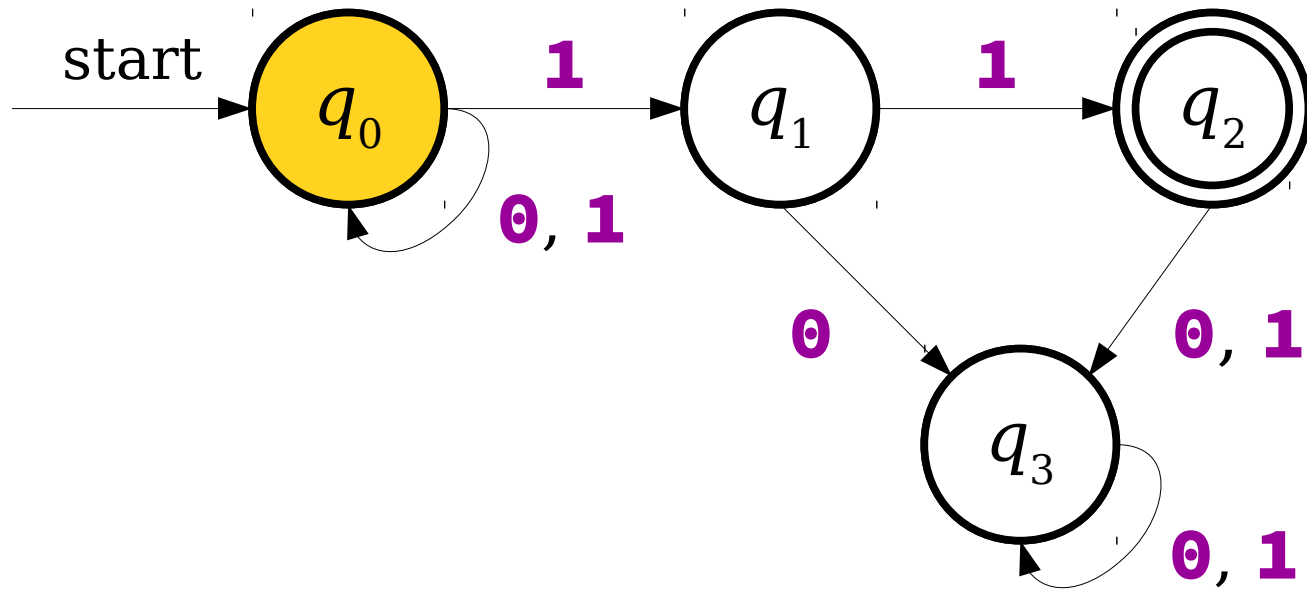

A Simple NFA

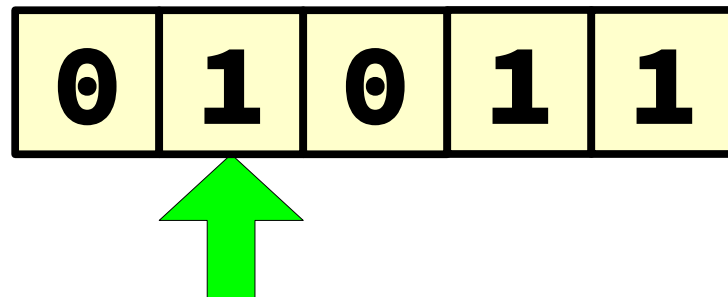
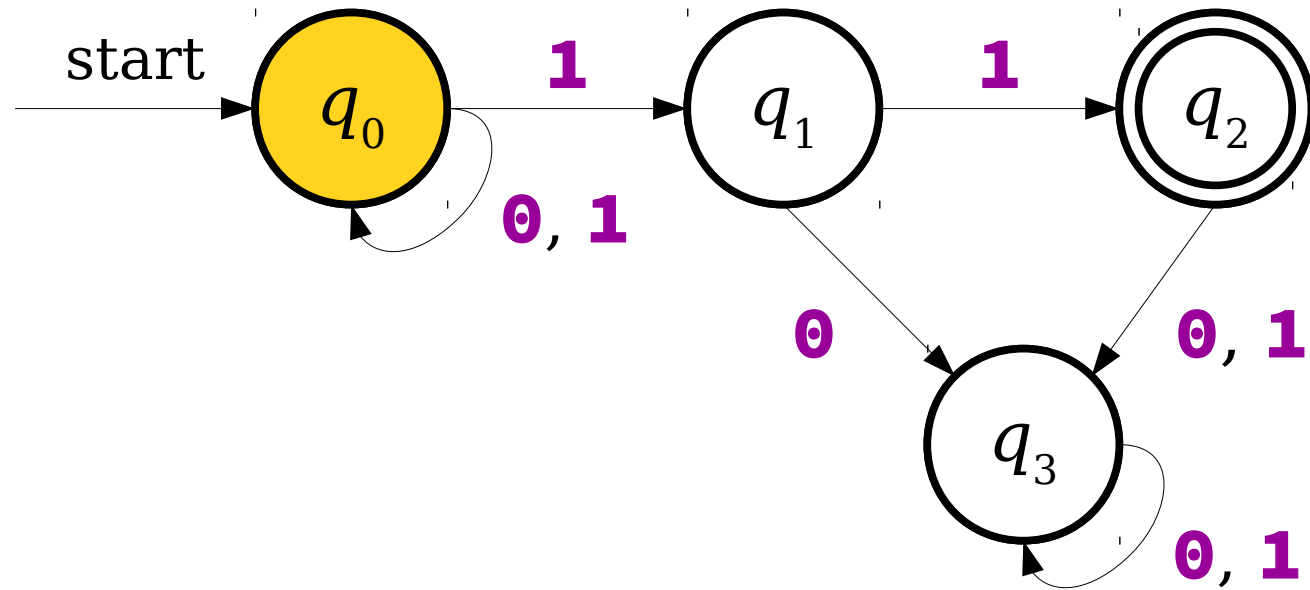

A Simple NFA

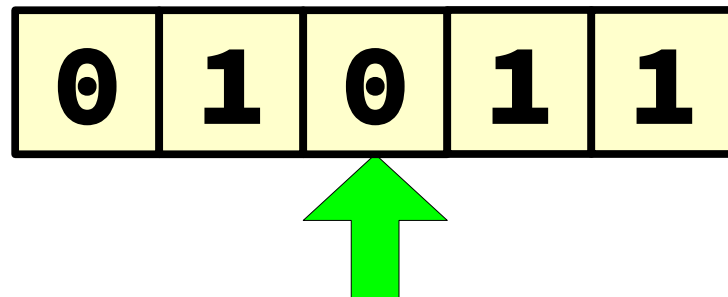
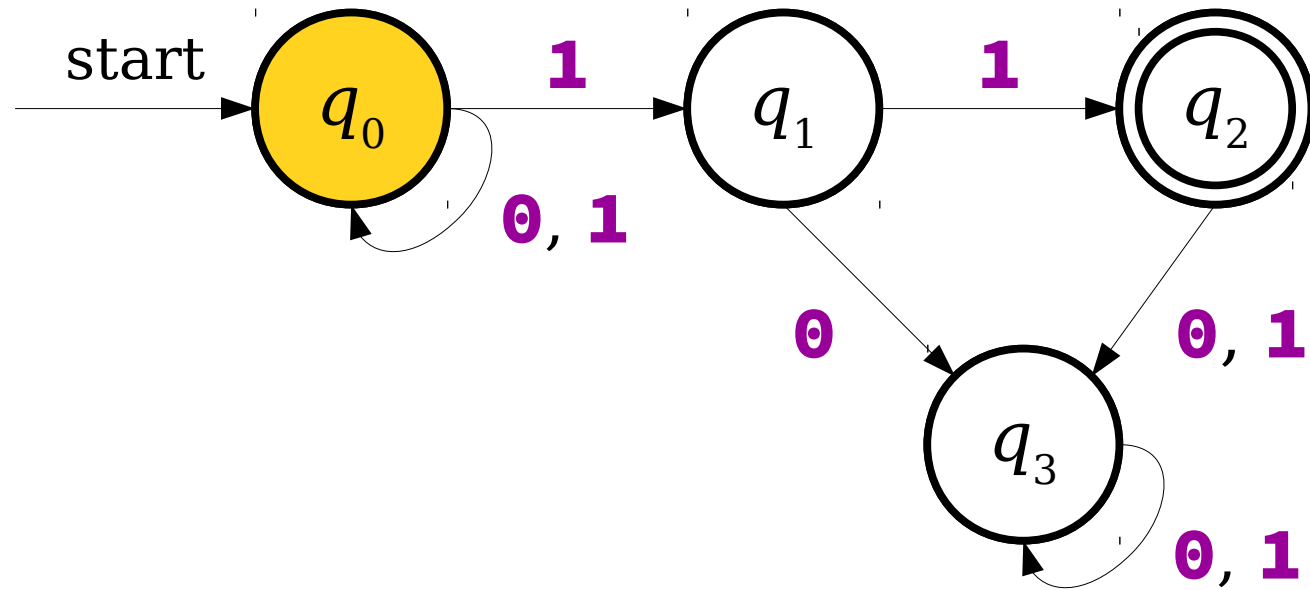

A Simple NFA

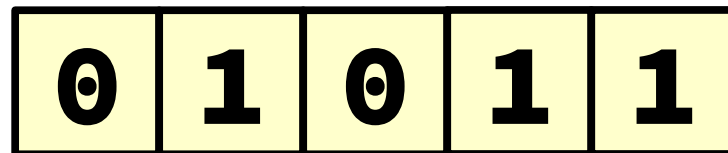
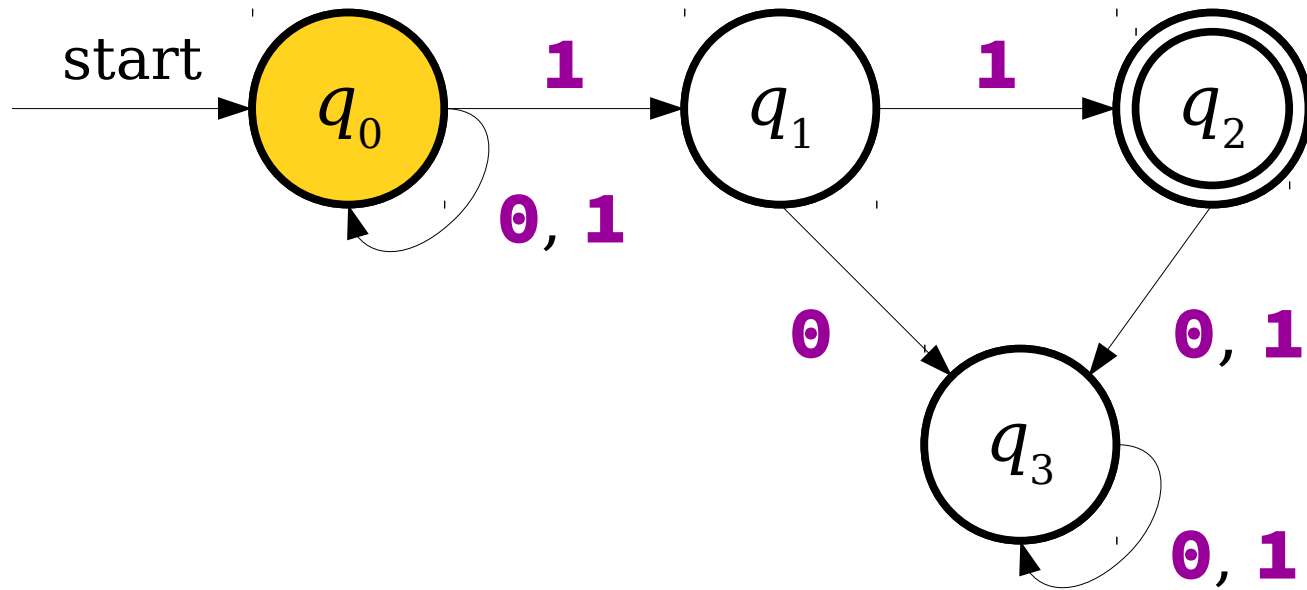

A Simple NFA

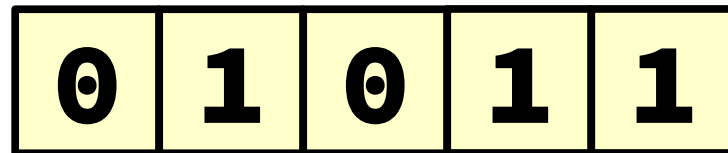
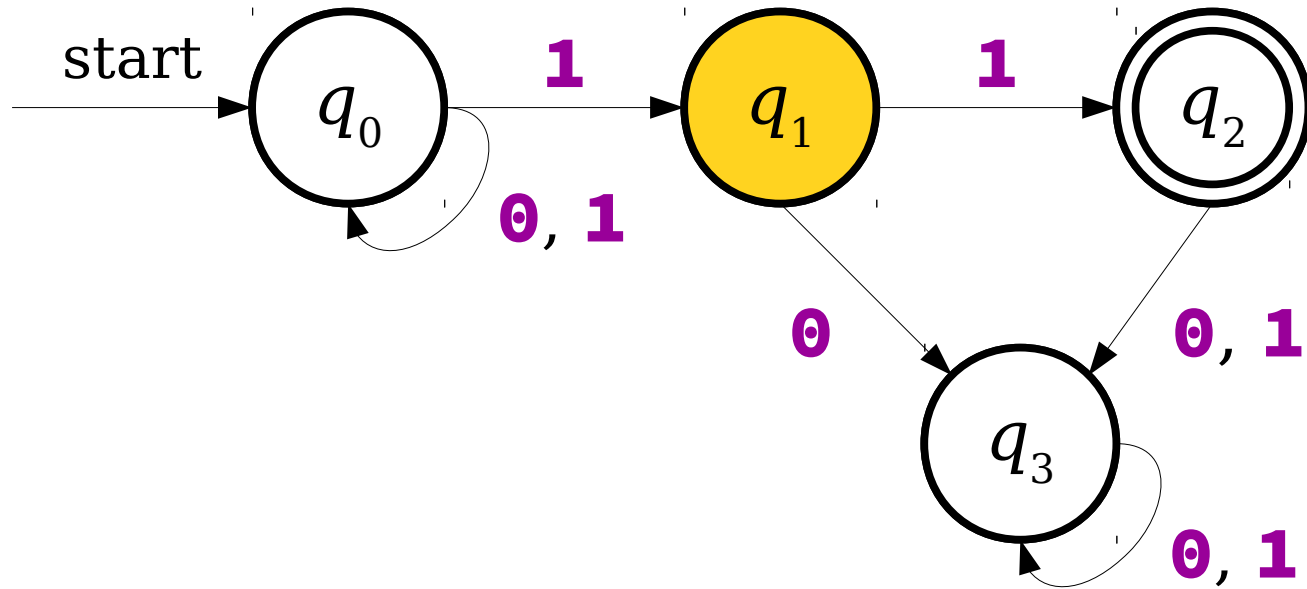

A Simple NFA

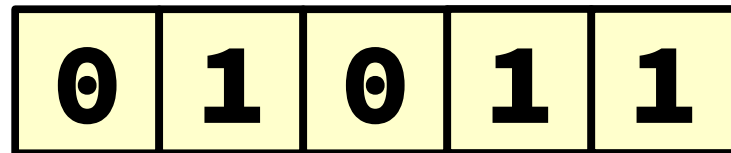
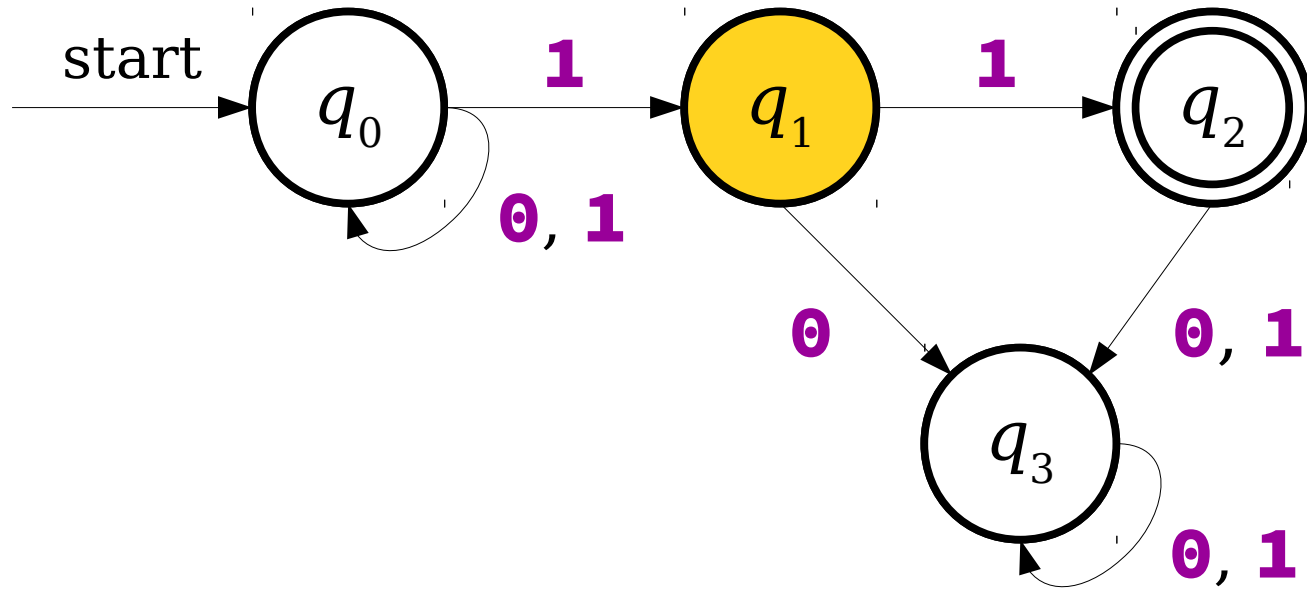

A Simple NFA

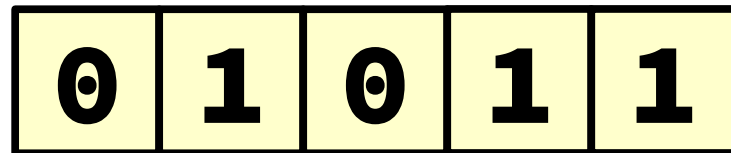
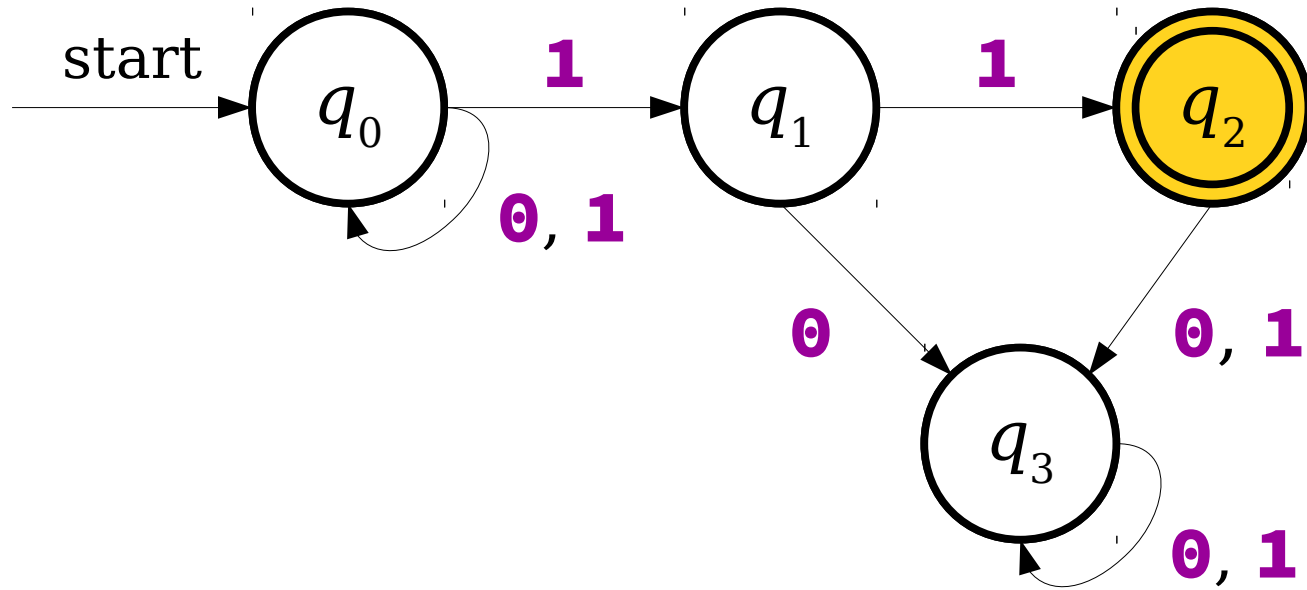

A Simple NFA

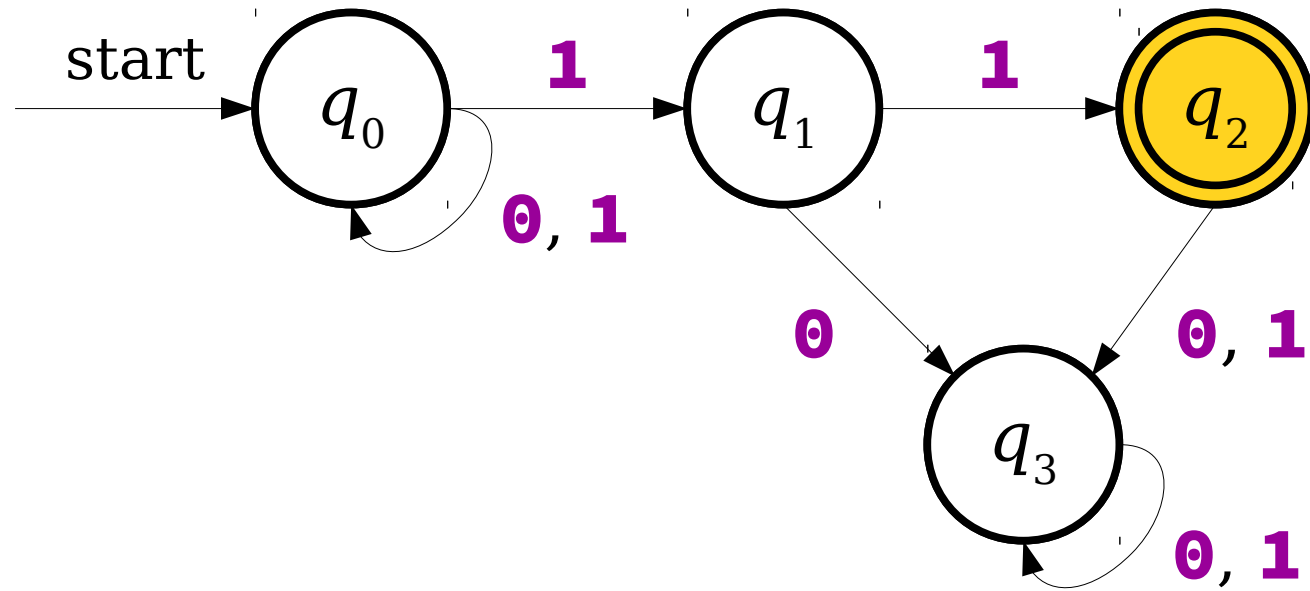

0	1	0	1	1
----------	----------	----------	----------	----------

A Simple NFA

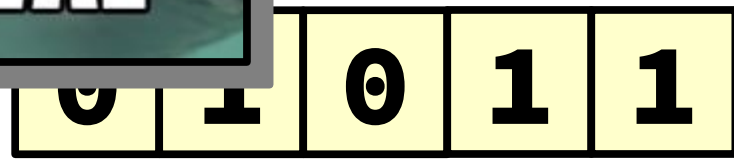
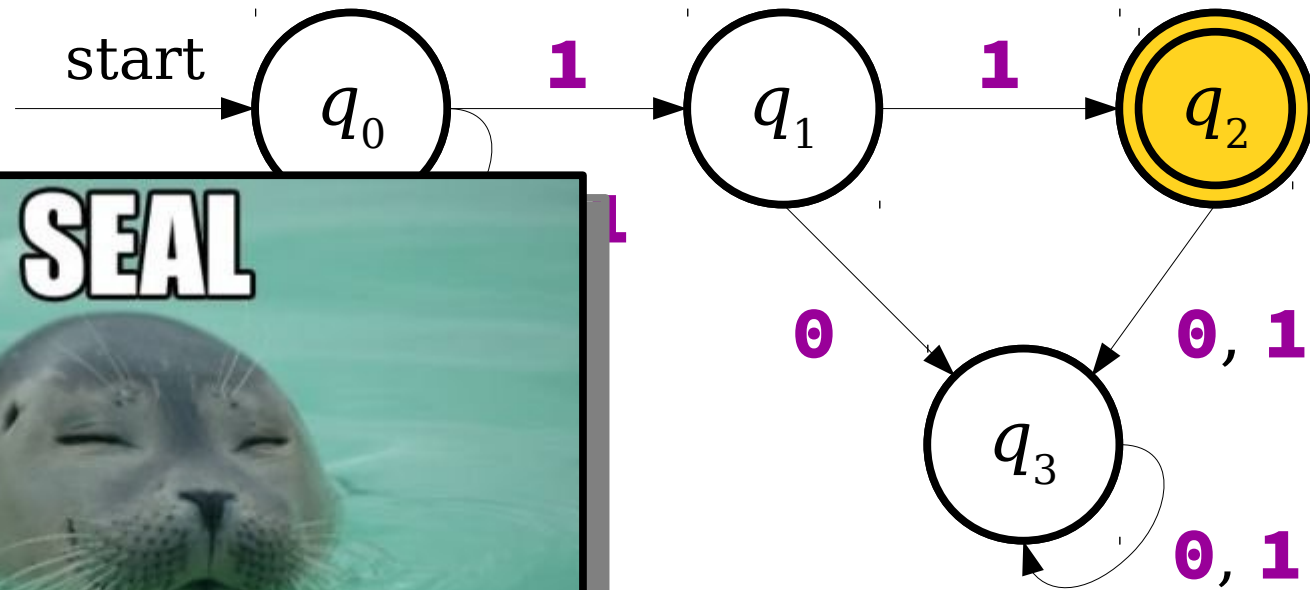

A More Complex NFA

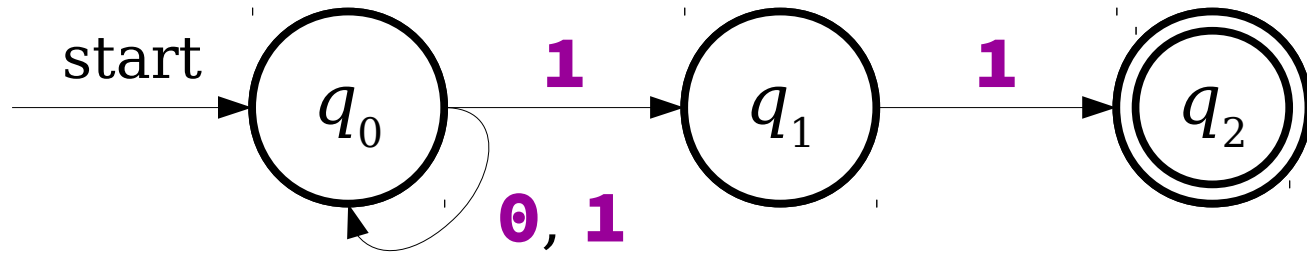

A More Complex NFA

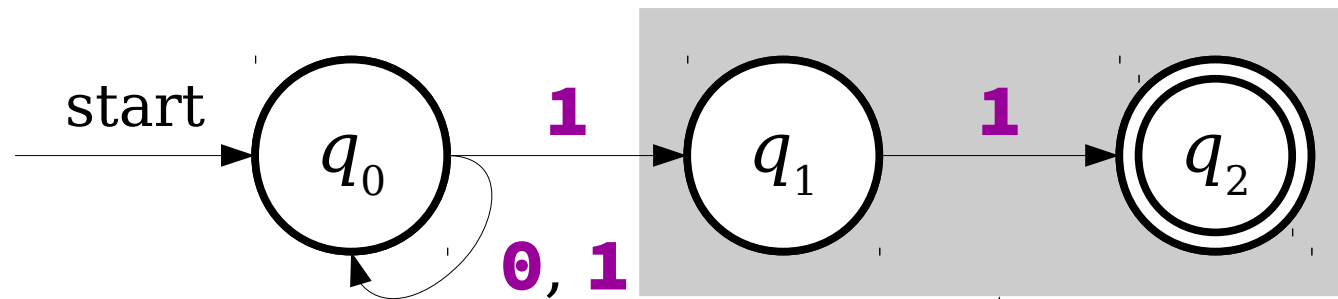

If a NFA needs to make a transition when no transition exists, the automaton **dies** and that particular path does not accept.

A More Complex NFA

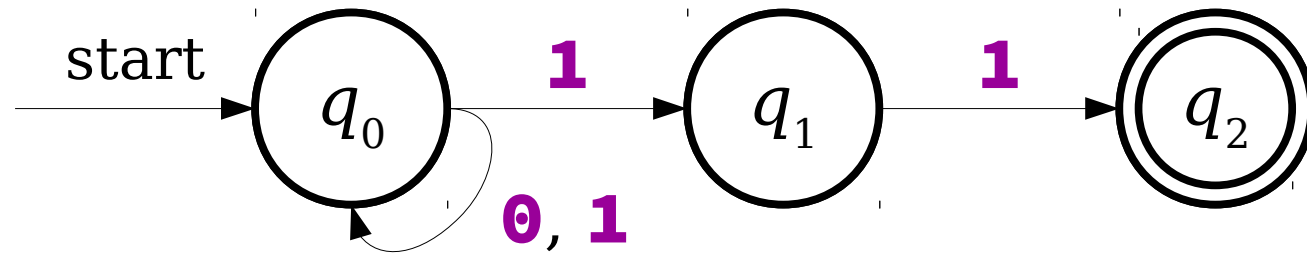

0	1	0	1	1
----------	----------	----------	----------	----------

A More Complex NFA

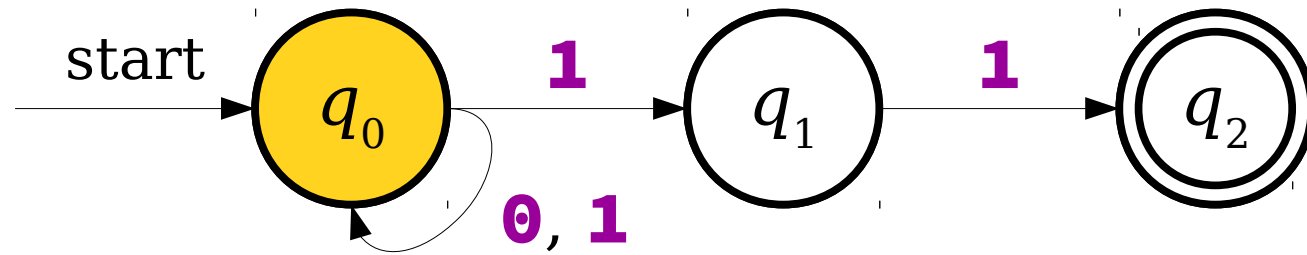

0	1	0	1	1
----------	----------	----------	----------	----------

A More Complex NFA

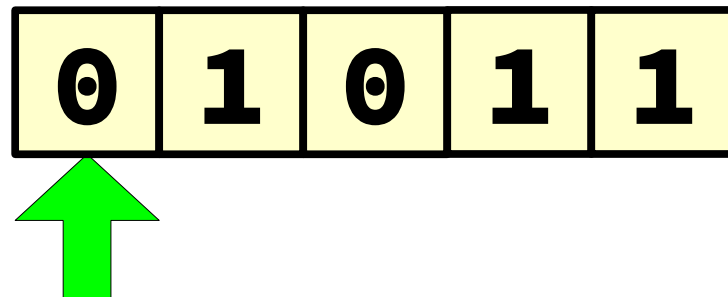
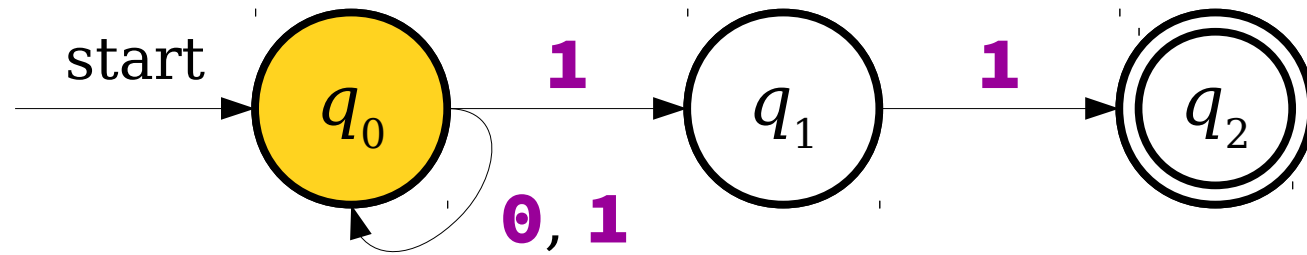

A More Complex NFA

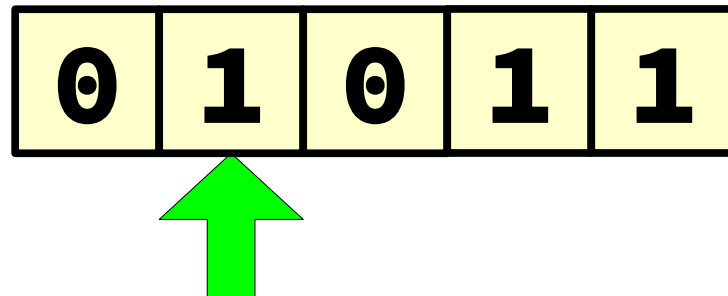
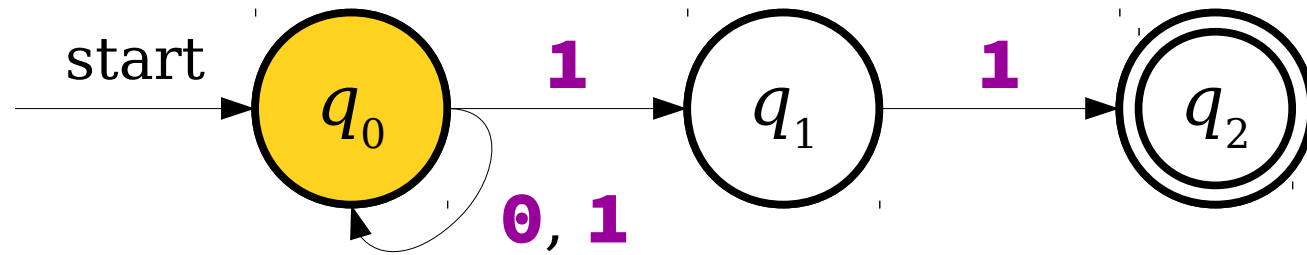

A More Complex NFA

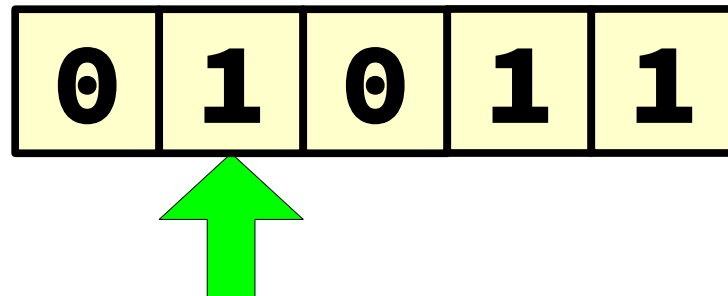
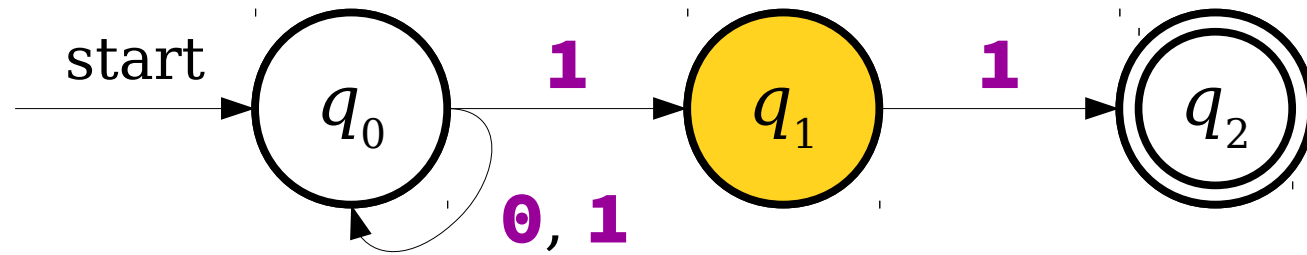

A More Complex NFA

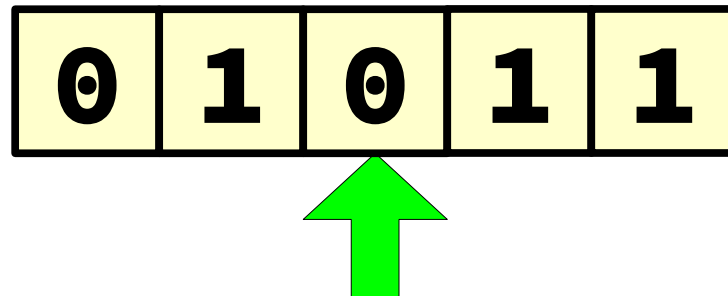
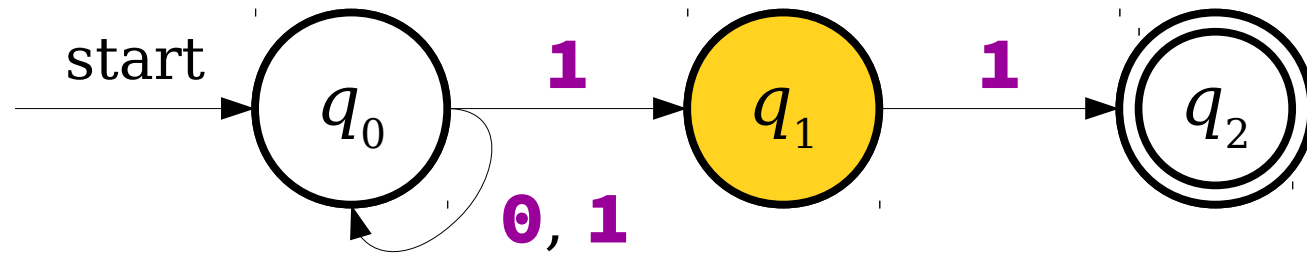

A More Complex NFA

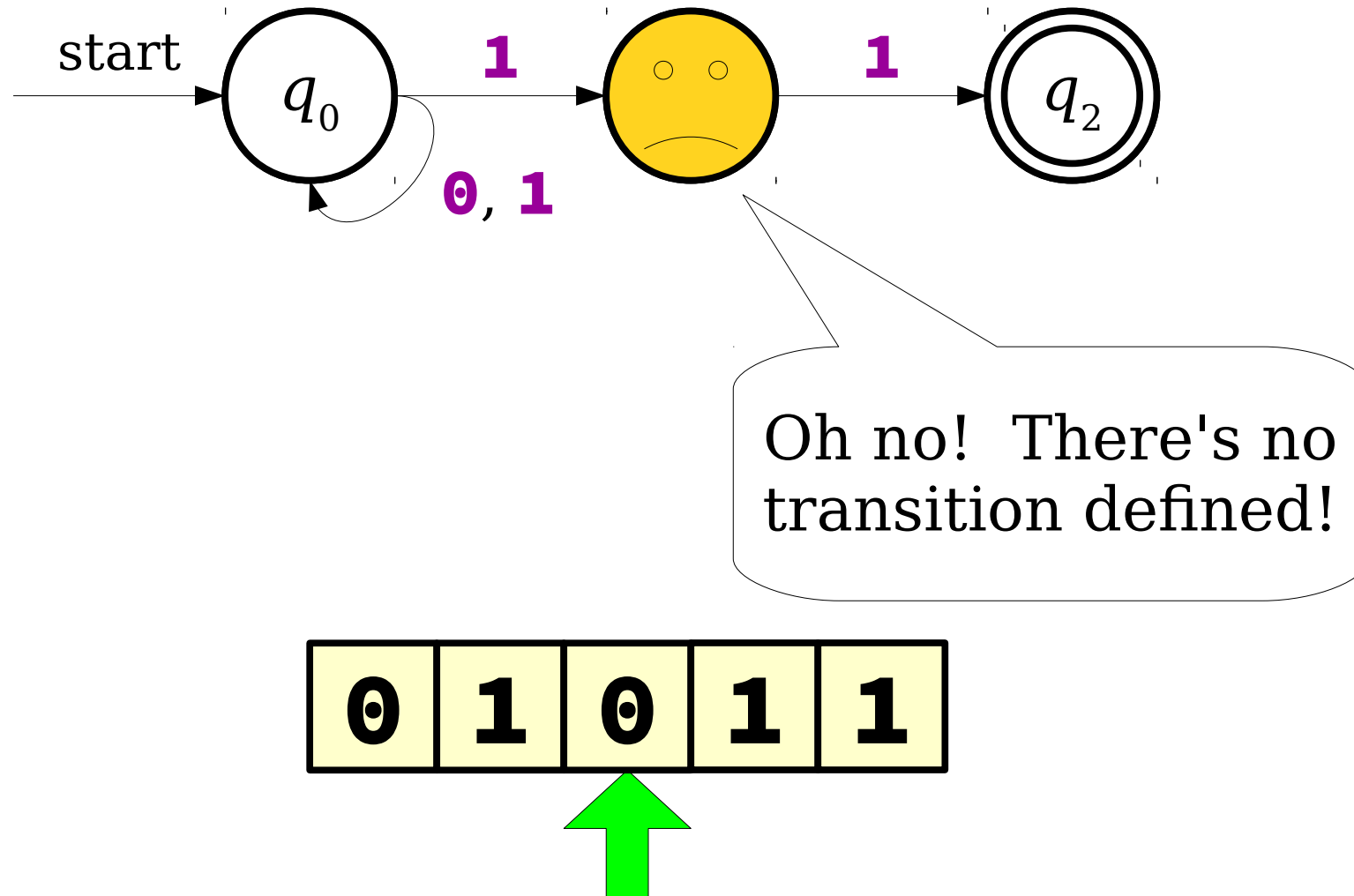

A More Complex NFA

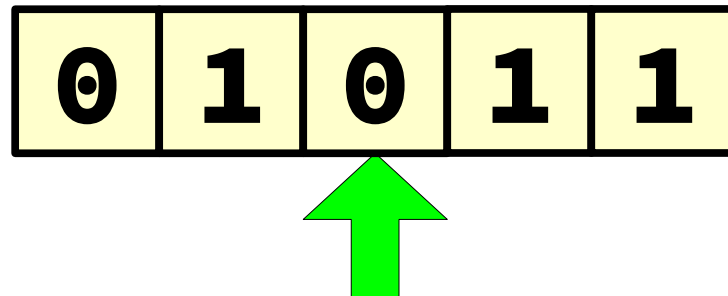
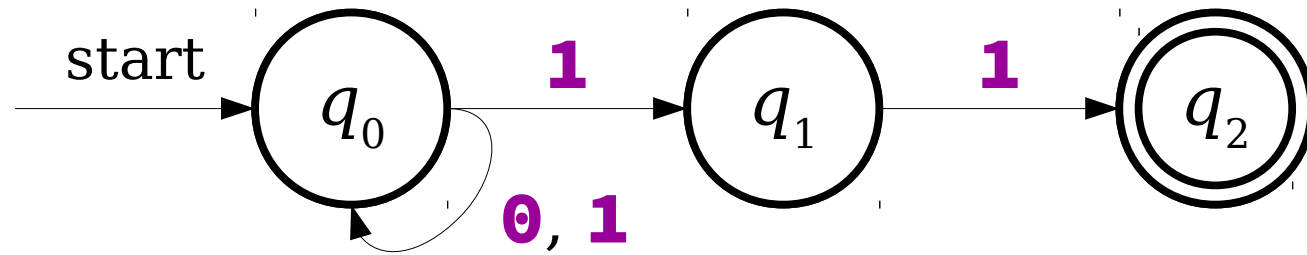

A More Complex NFA

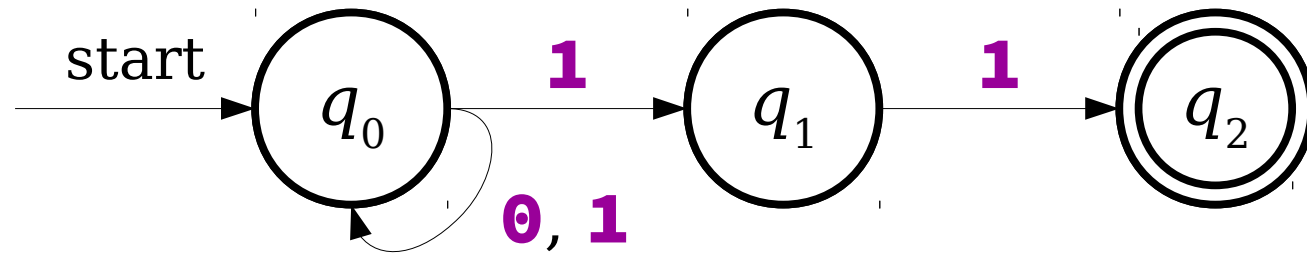

0	1	0	1	1
----------	----------	----------	----------	----------

A More Complex NFA

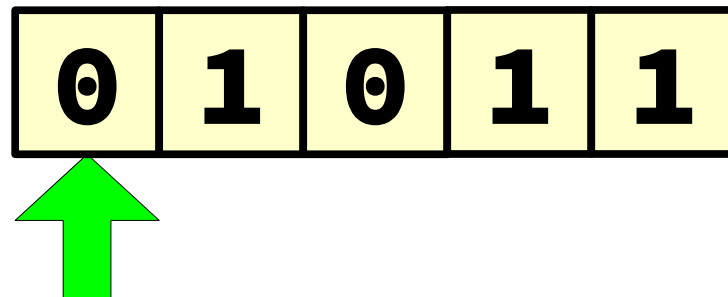
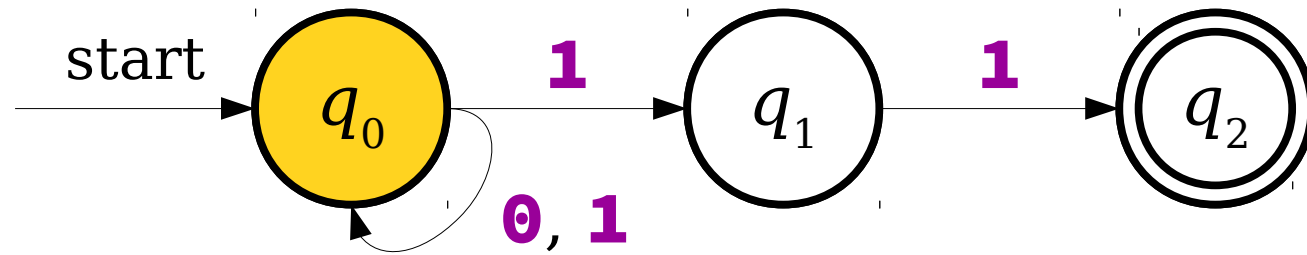

A More Complex NFA

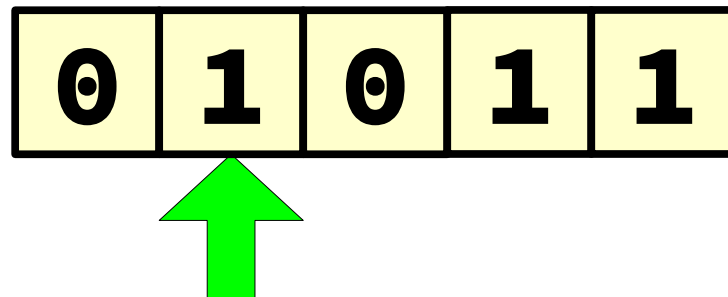
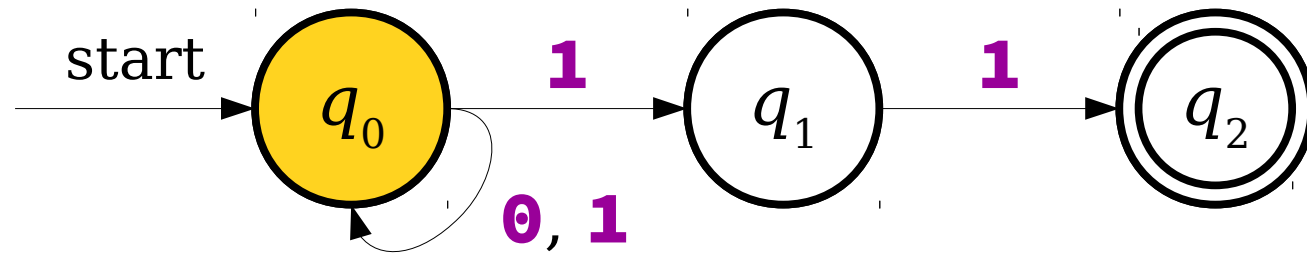

A More Complex NFA

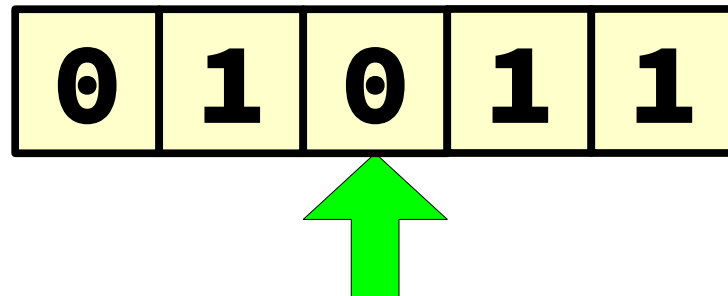
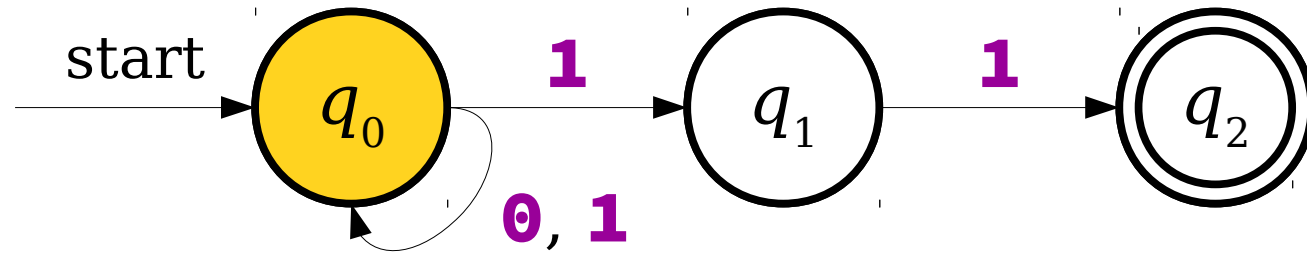

A More Complex NFA

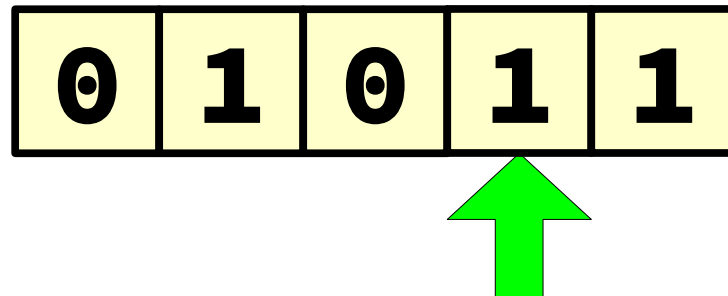
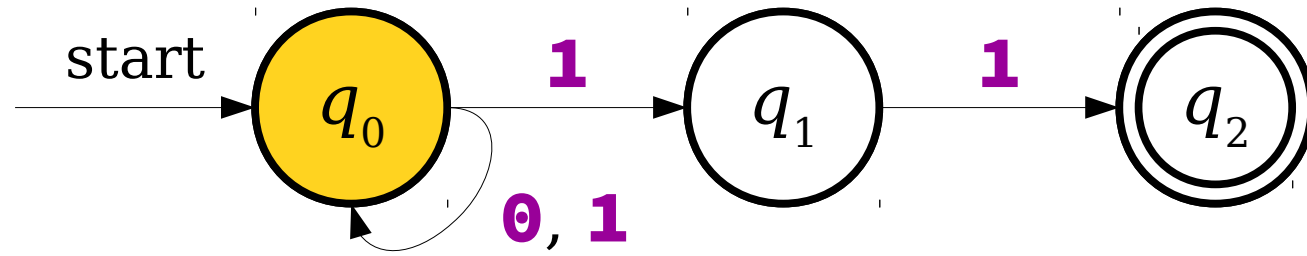

A More Complex NFA

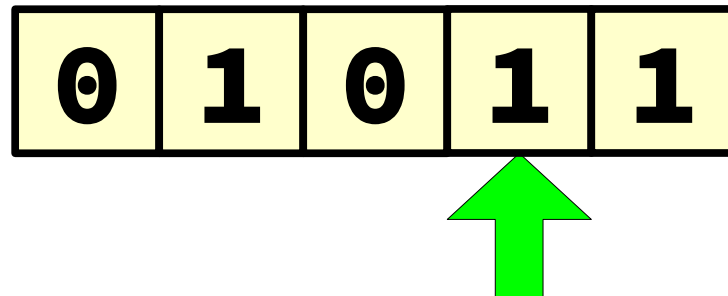
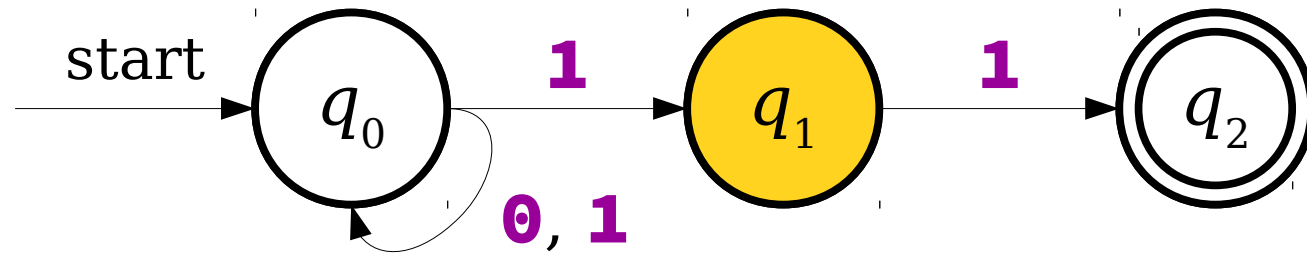

A More Complex NFA

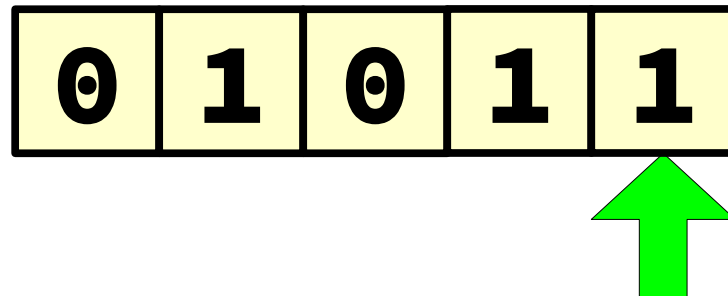
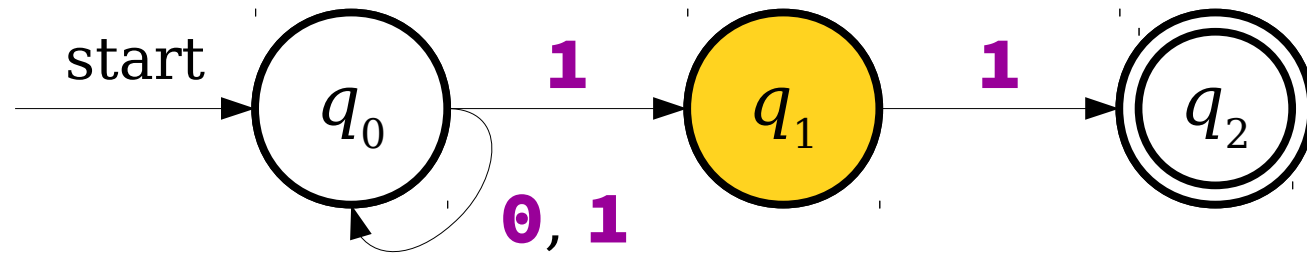

A More Complex NFA

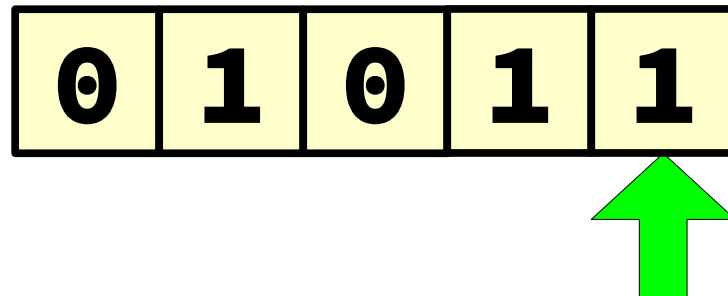
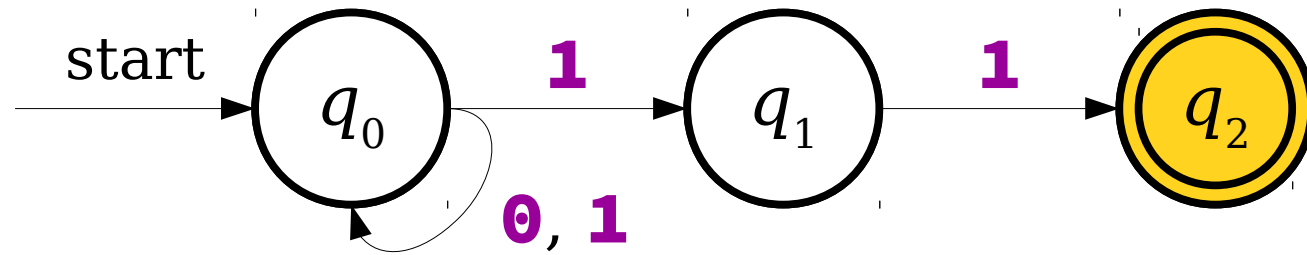

A More Complex NFA

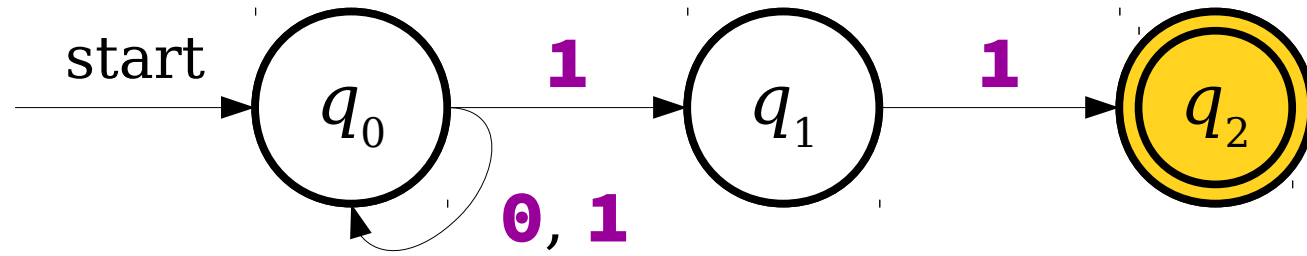

0	1	0	1	1
----------	----------	----------	----------	----------

A More Complex NFA

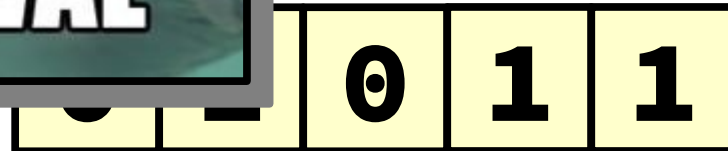
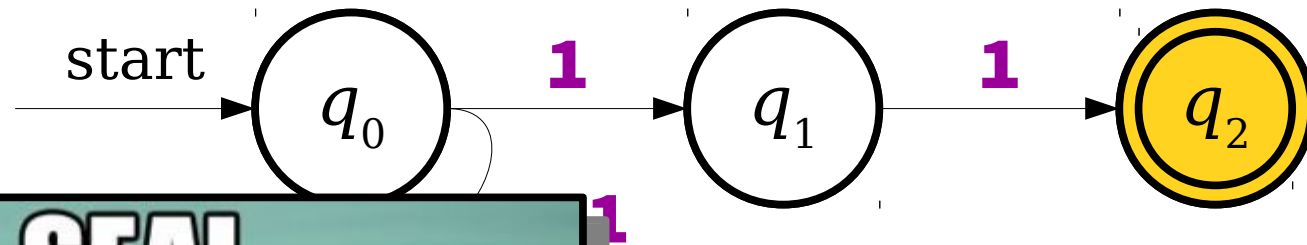

Hello, NFA!

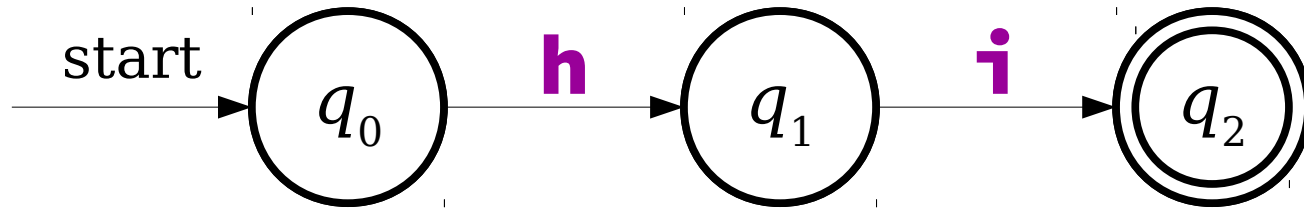

h	i
----------	----------

Hello, NFA!

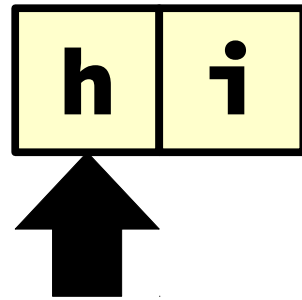
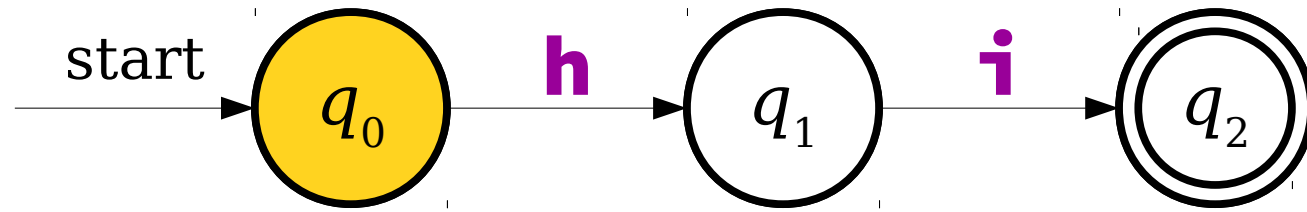

Hello, NFA!

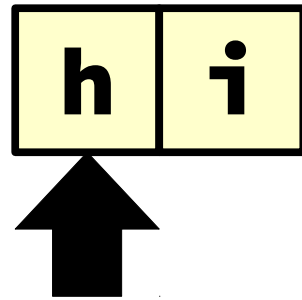
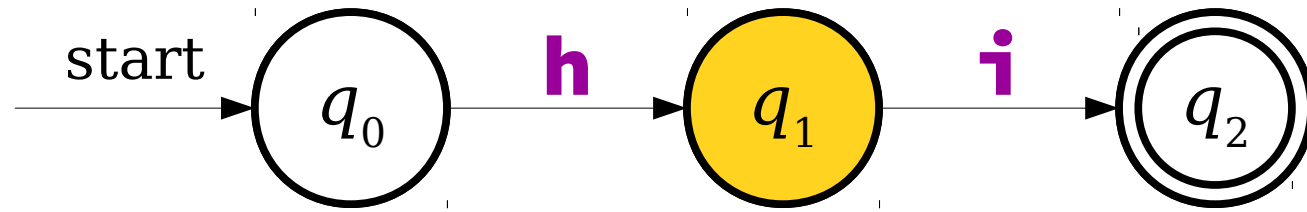

Hello, NFA!

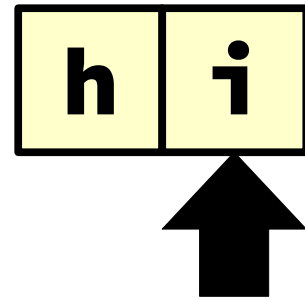
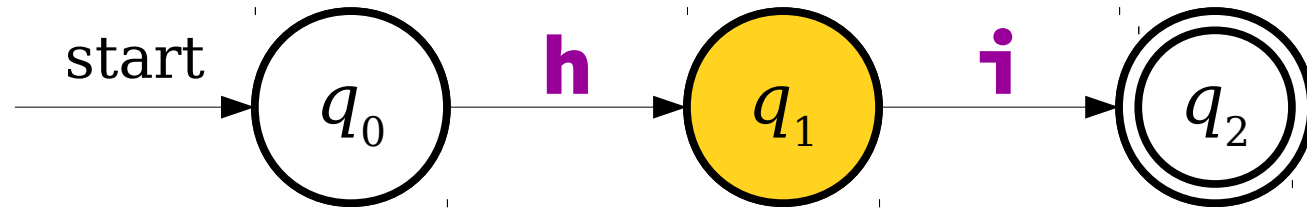

Hello, NFA!

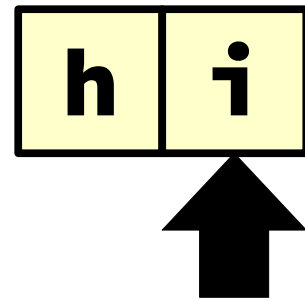
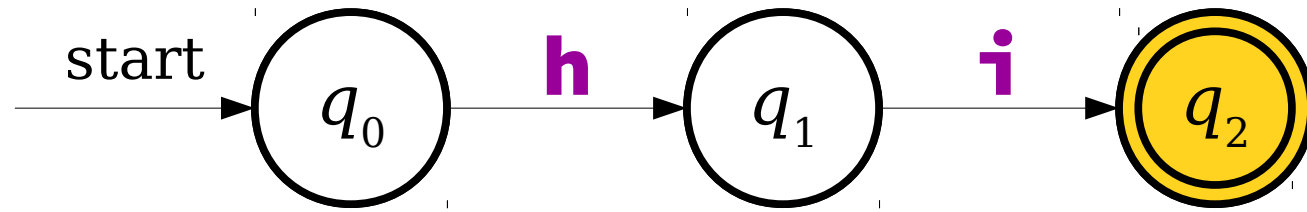

Hello, NFA!

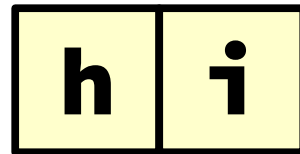
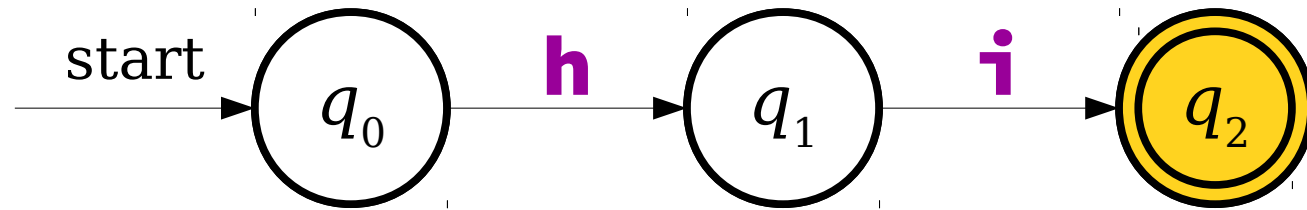

Tragedy in Paradise

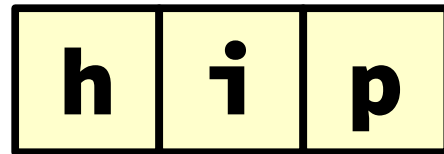
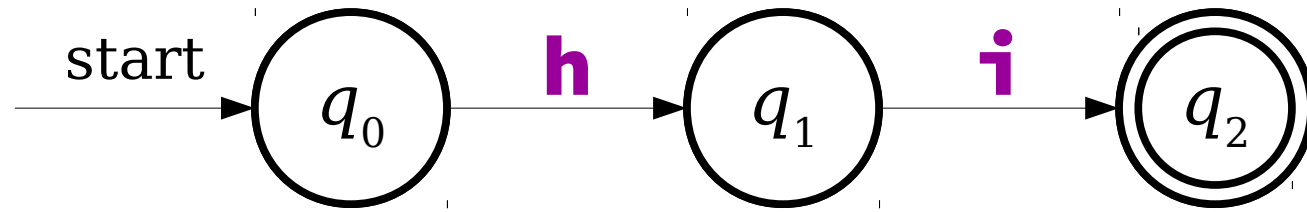

Tragedy in Paradise

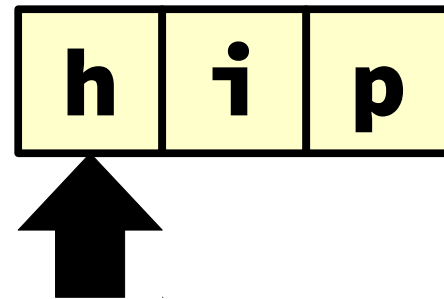
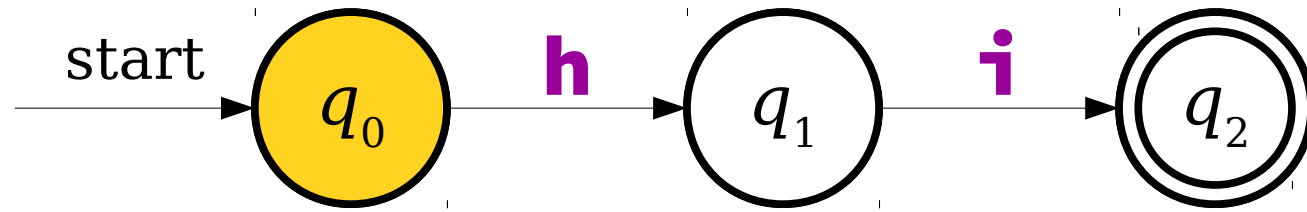

Tragedy in Paradise

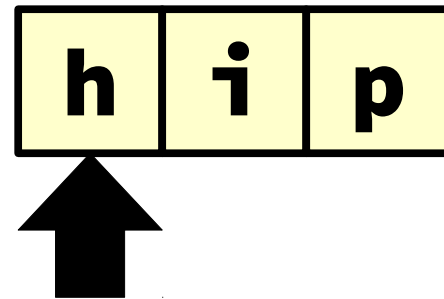
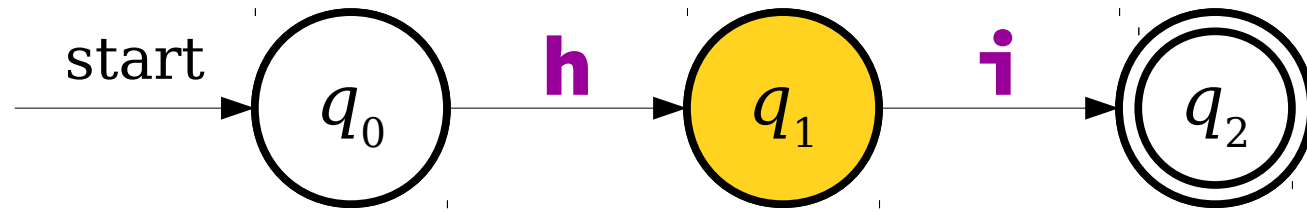

Tragedy in Paradise

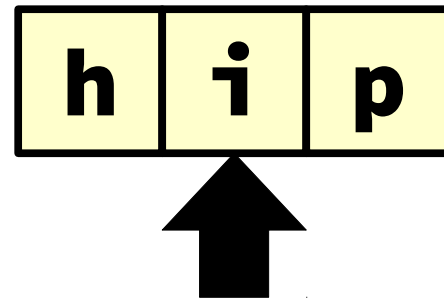
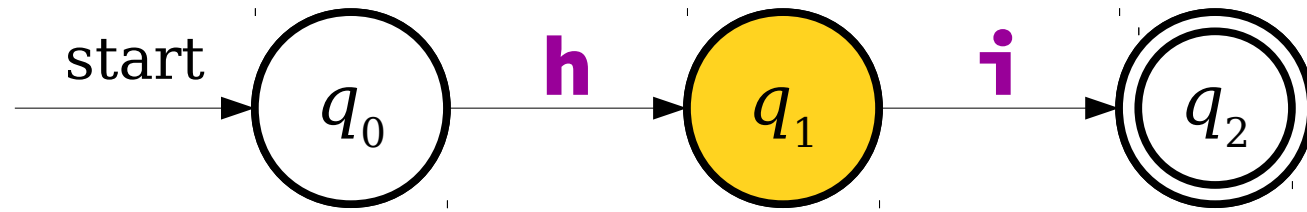

Tragedy in Paradise

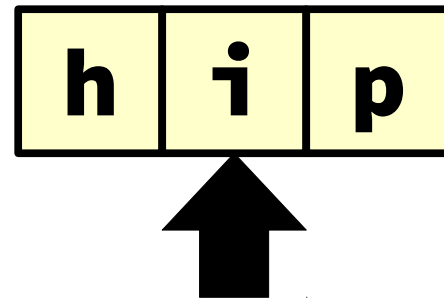
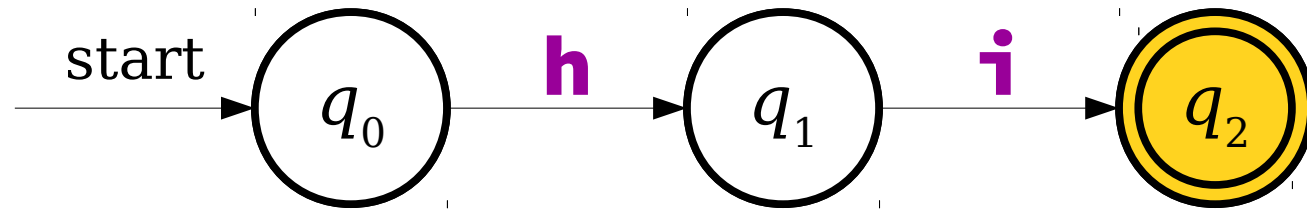

Tragedy in Paradise

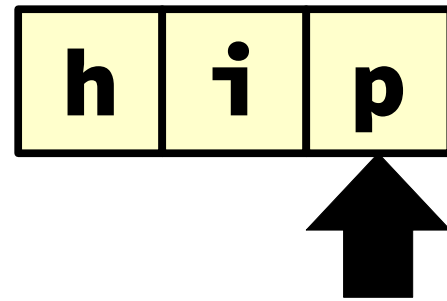
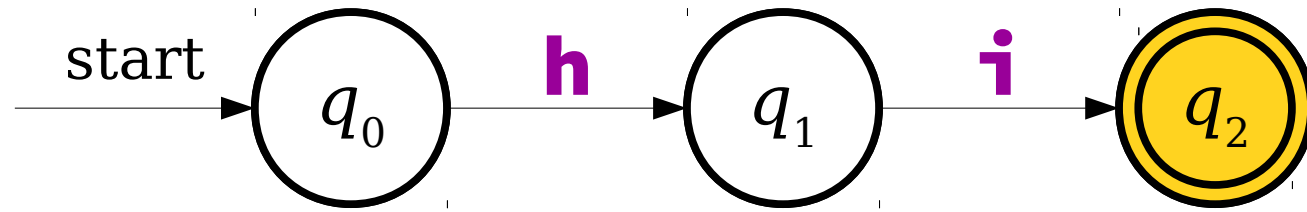

Tragedy in Paradise

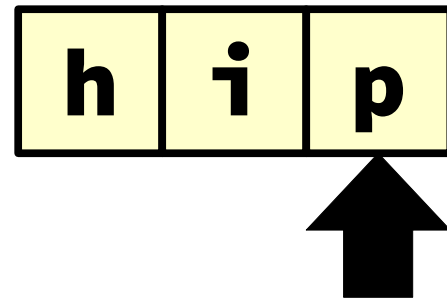
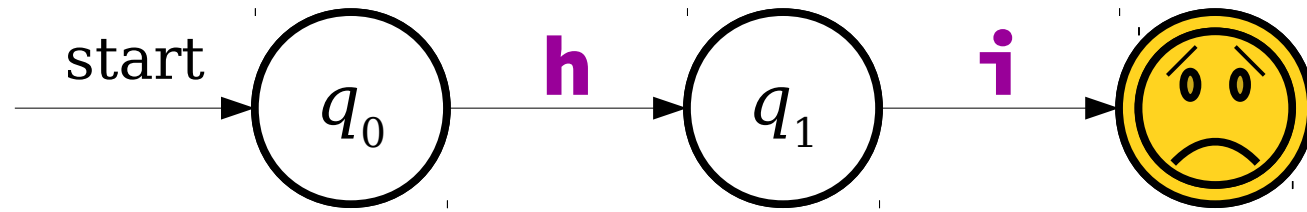

Tragedy in Paradise

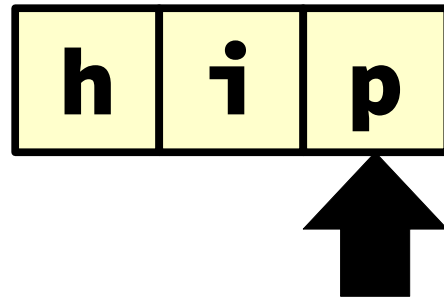
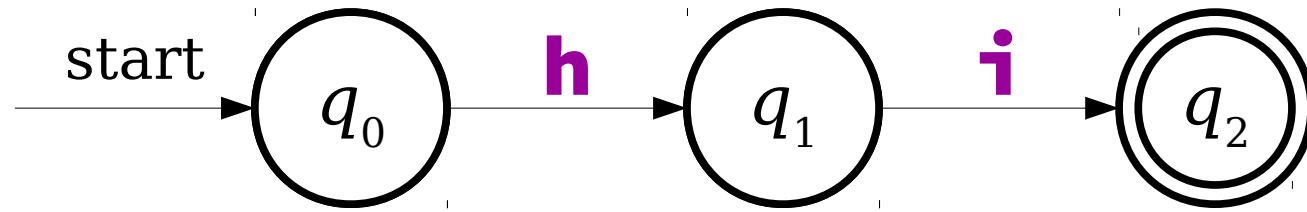

ϵ -Transitions

- NFAs have a special type of transition called the **ϵ -transition**.
- An NFA may follow any number of ϵ -transitions at any time without consuming any input.

ϵ -Transitions

- NFAs have a special type of transition called the **ϵ -transition**.
- An NFA may follow any number of ϵ -transitions at any time without consuming any input.

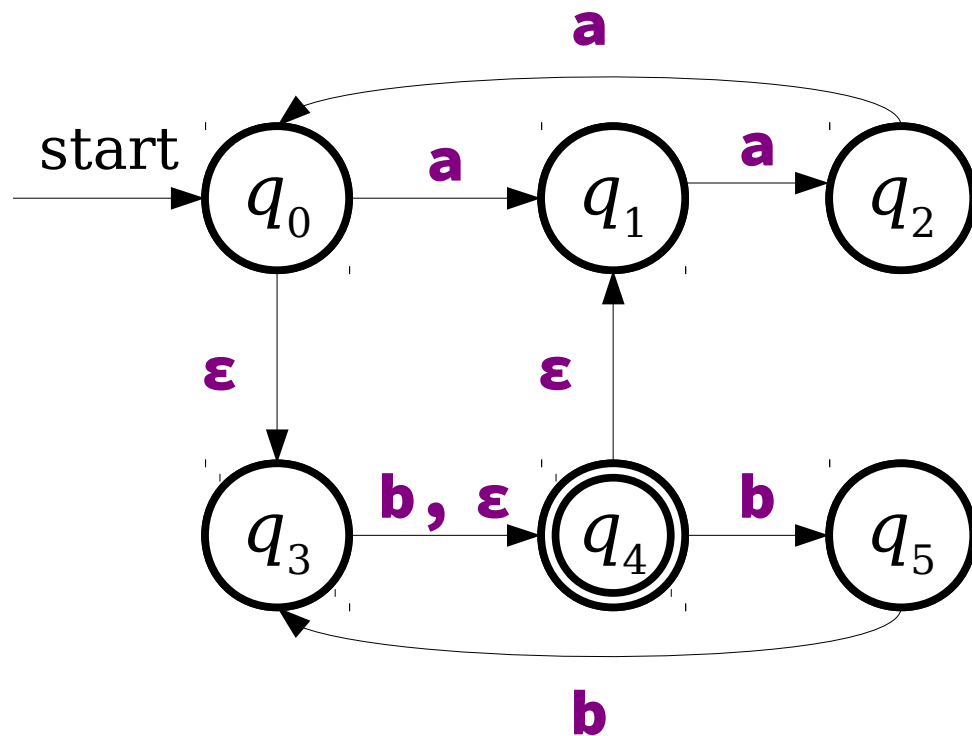

ϵ -Transitions

- NFAs have a special type of transition called the **ϵ -transition**.
- An NFA may follow any number of ϵ -transitions at any time without consuming any input.

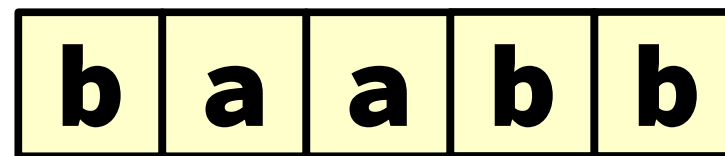
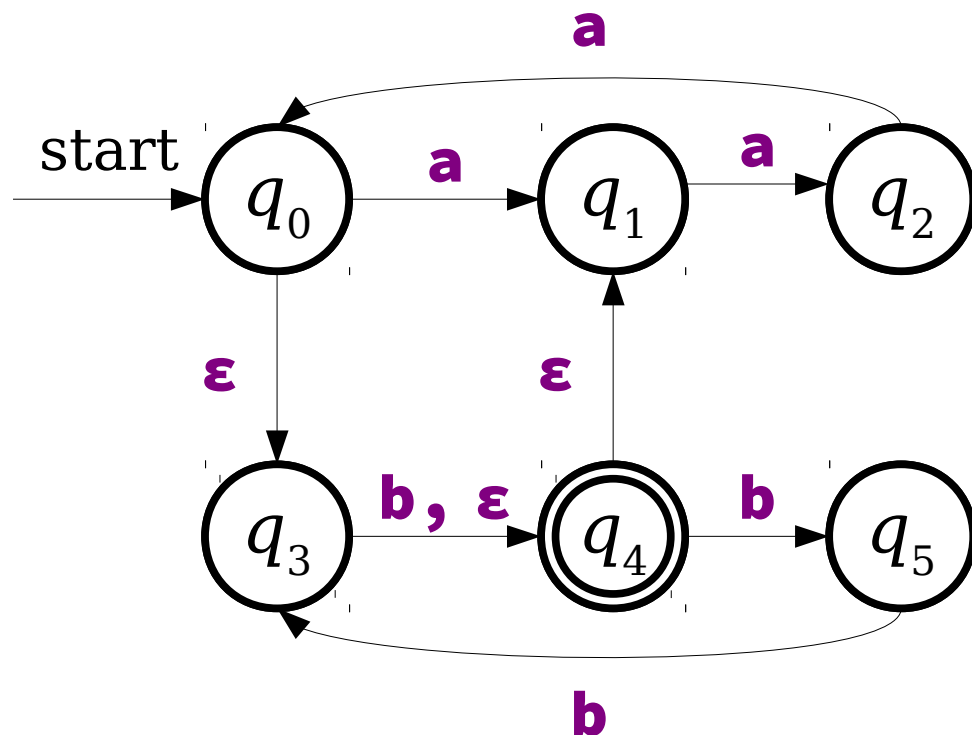

ϵ -Transitions

- NFAs have a special type of transition called the **ϵ -transition**.
- An NFA may follow any number of ϵ -transitions at any time without consuming any input.

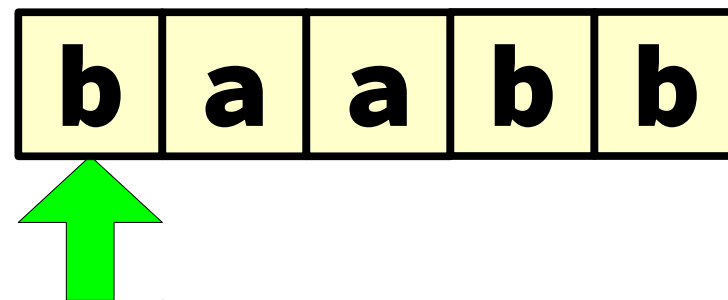
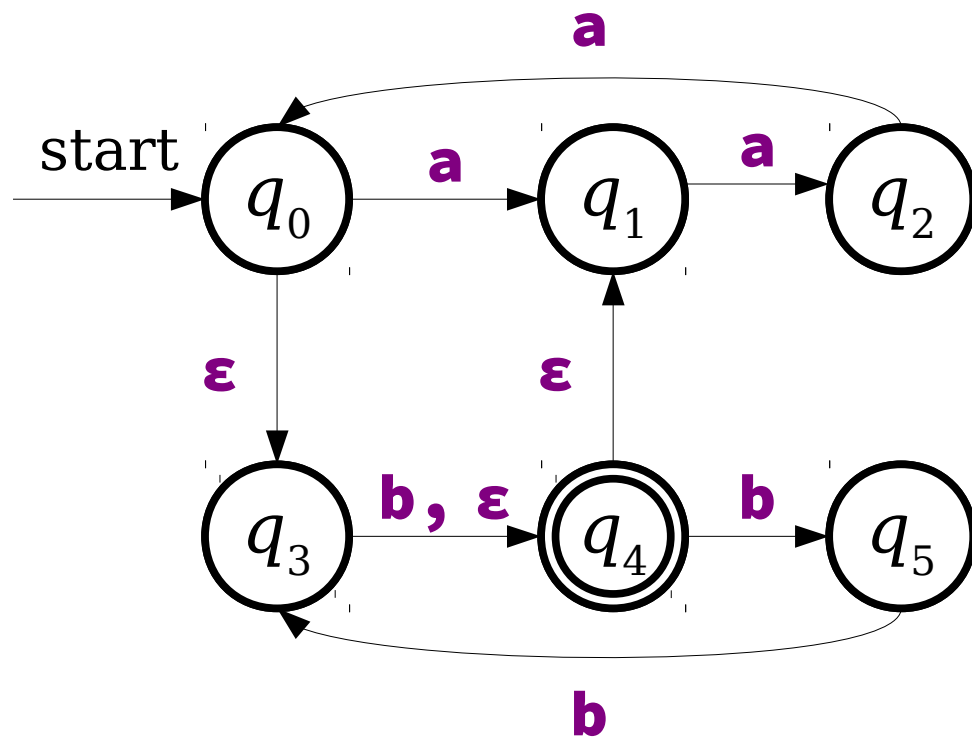

ϵ -Transitions

- NFAs have a special type of transition called the **ϵ -transition**.
- An NFA may follow any number of ϵ -transitions at any time without consuming any input.

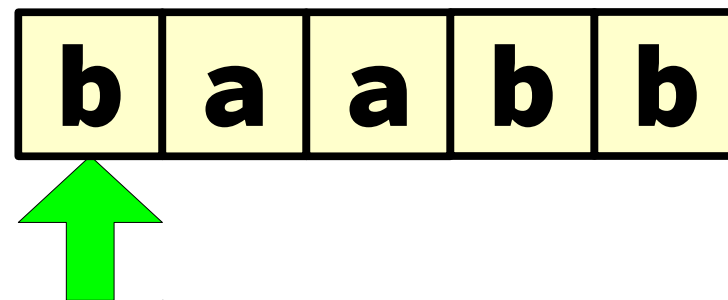
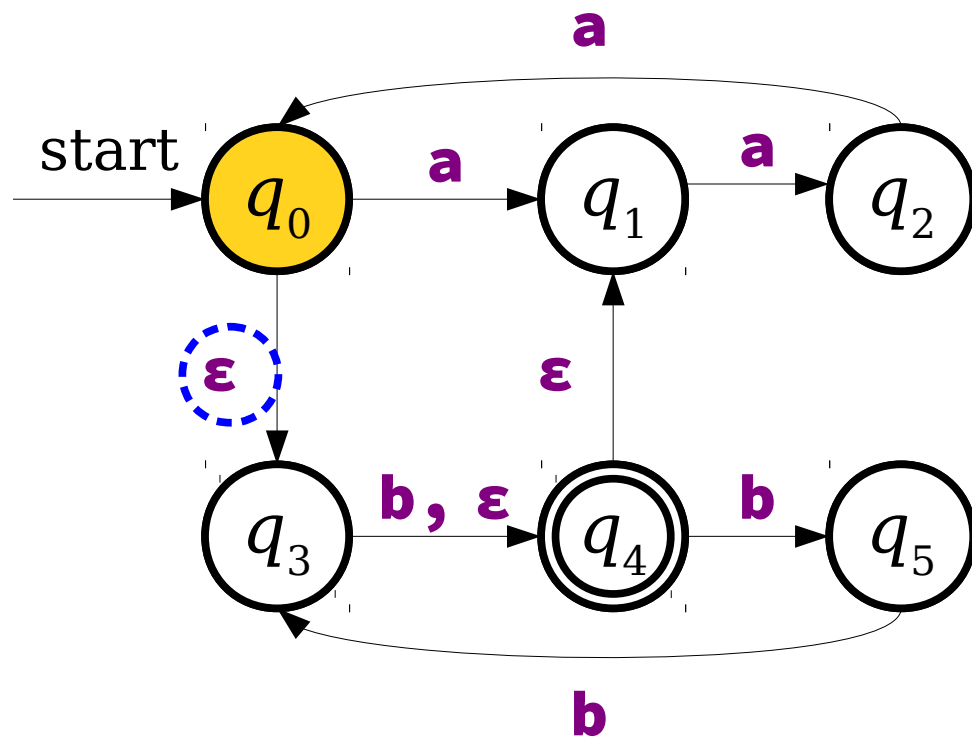

ϵ -Transitions

- NFAs have a special type of transition called the **ϵ -transition**.
- An NFA may follow any number of ϵ -transitions at any time without consuming any input.

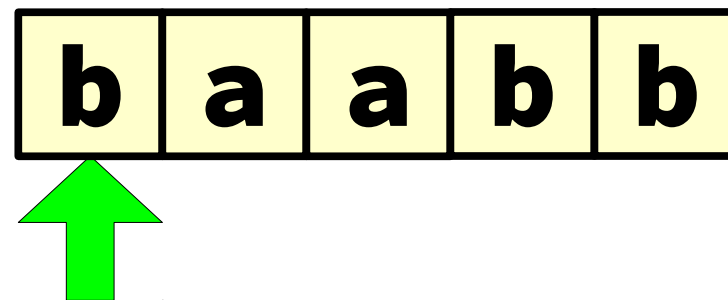
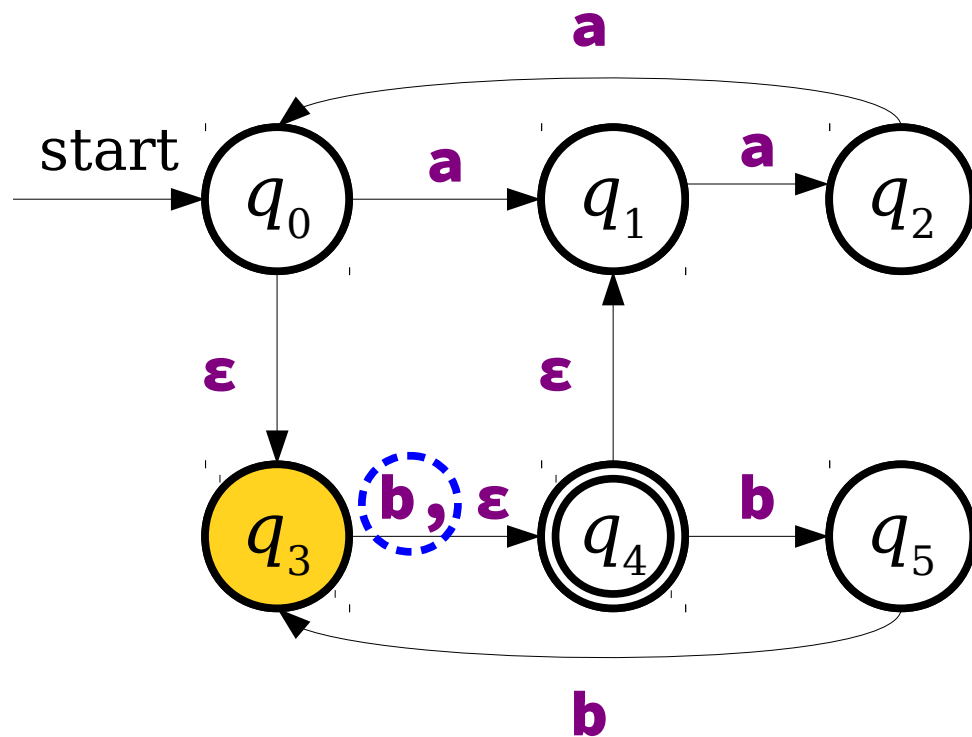

ϵ -Transitions

- NFAs have a special type of transition called the **ϵ -transition**.
- An NFA may follow any number of ϵ -transitions at any time without consuming any input.

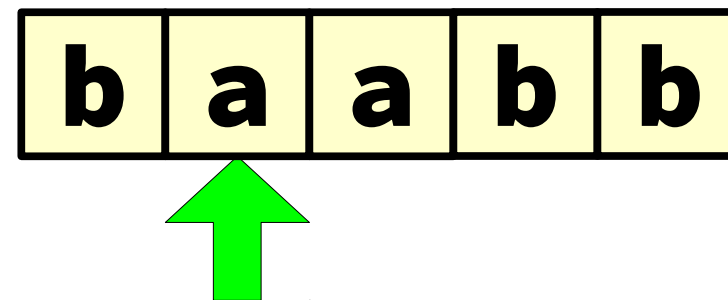
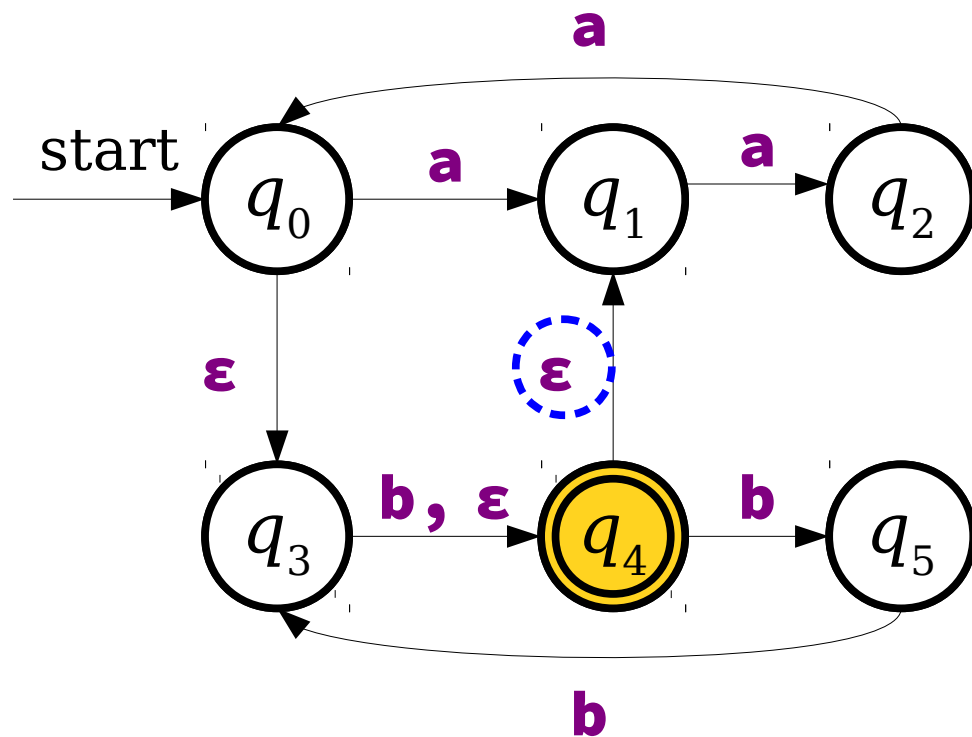

ϵ -Transitions

- NFAs have a special type of transition called the **ϵ -transition**.
- An NFA may follow any number of ϵ -transitions at any time without consuming any input.

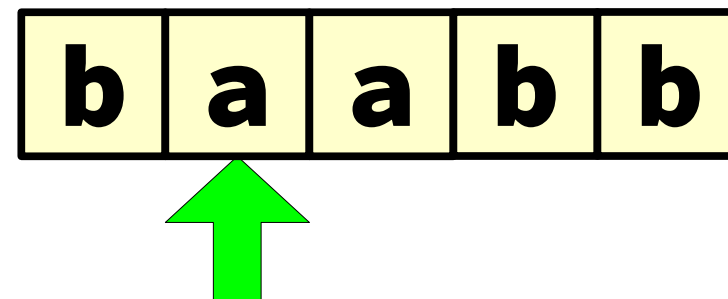
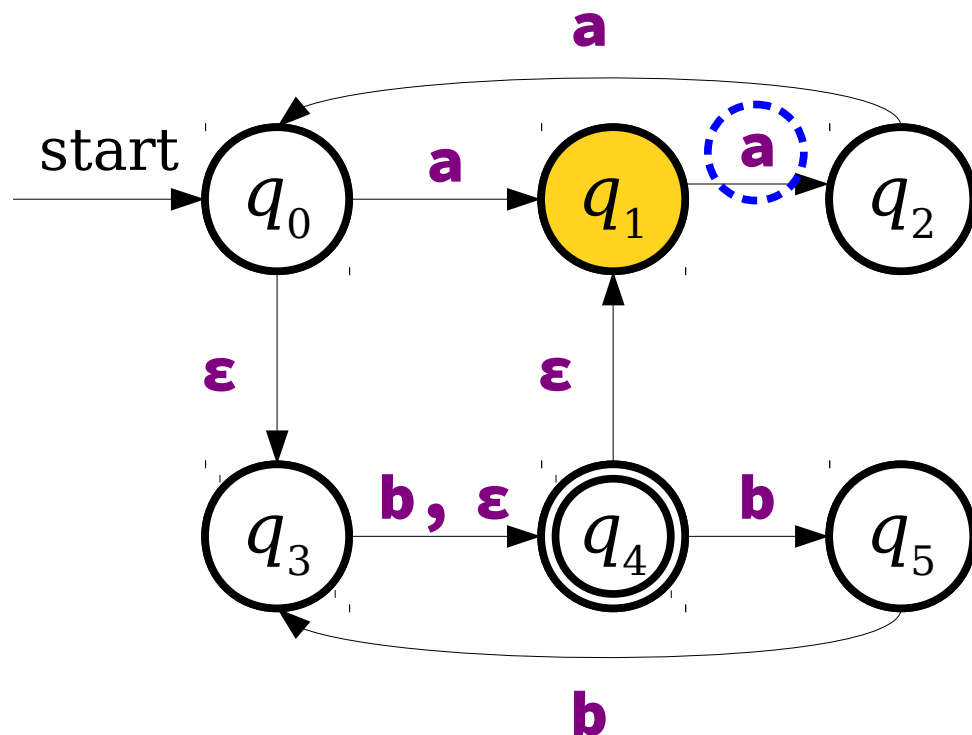

ϵ -Transitions

- NFAs have a special type of transition called the **ϵ -transition**.
- An NFA may follow any number of ϵ -transitions at any time without consuming any input.

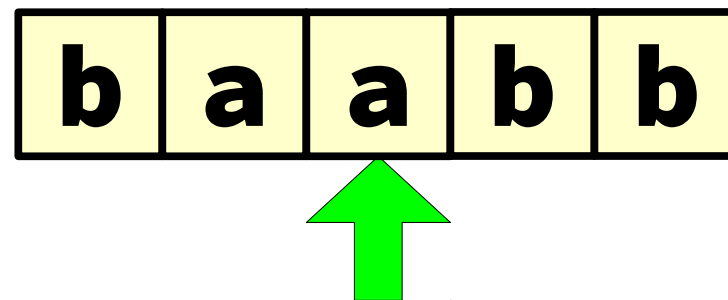
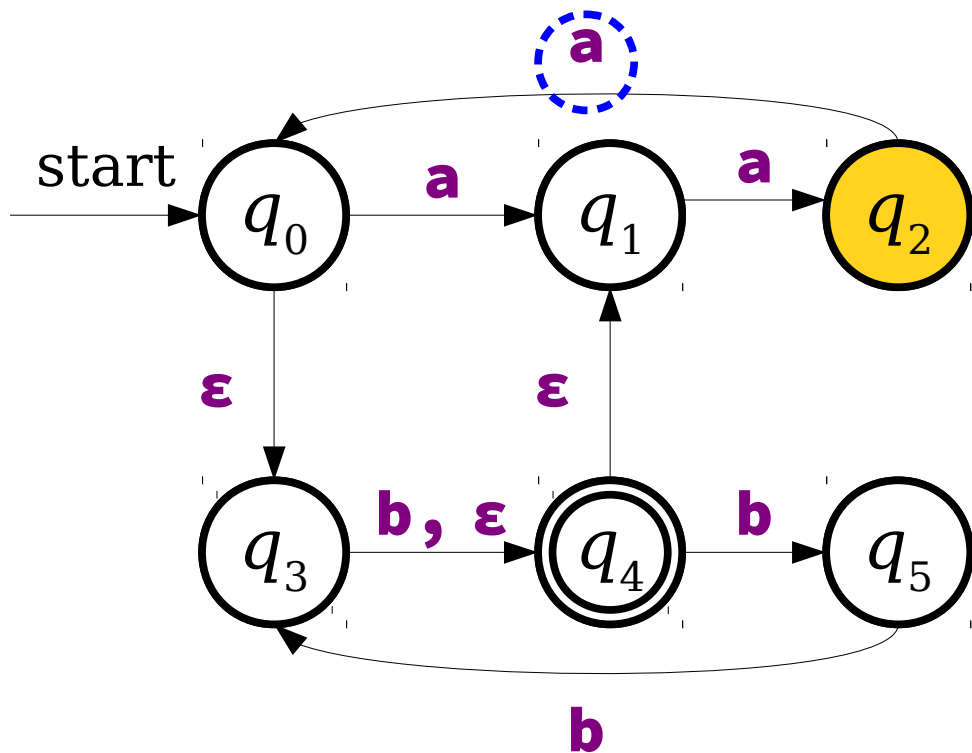

ϵ -Transitions

- NFAs have a special type of transition called the **ϵ -transition**.
- An NFA may follow any number of ϵ -transitions at any time without consuming any input.

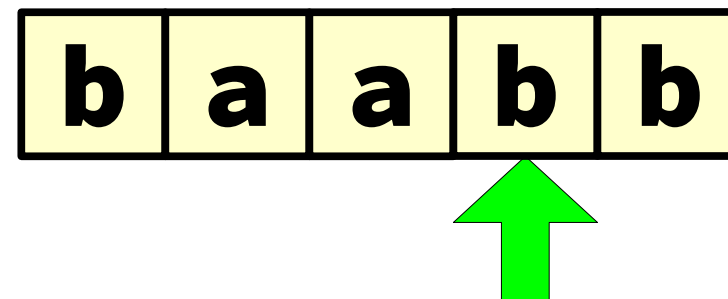
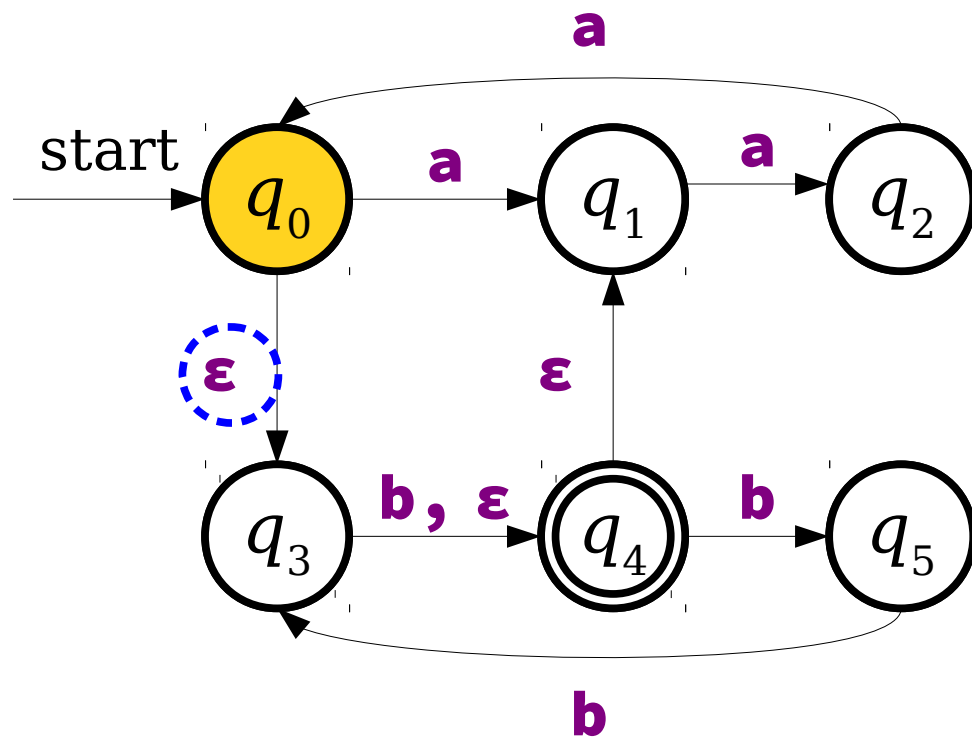

ϵ -Transitions

- NFAs have a special type of transition called the **ϵ -transition**.
- An NFA may follow any number of ϵ -transitions at any time without consuming any input.

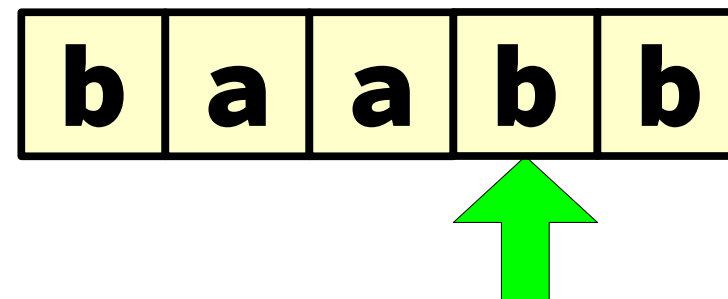
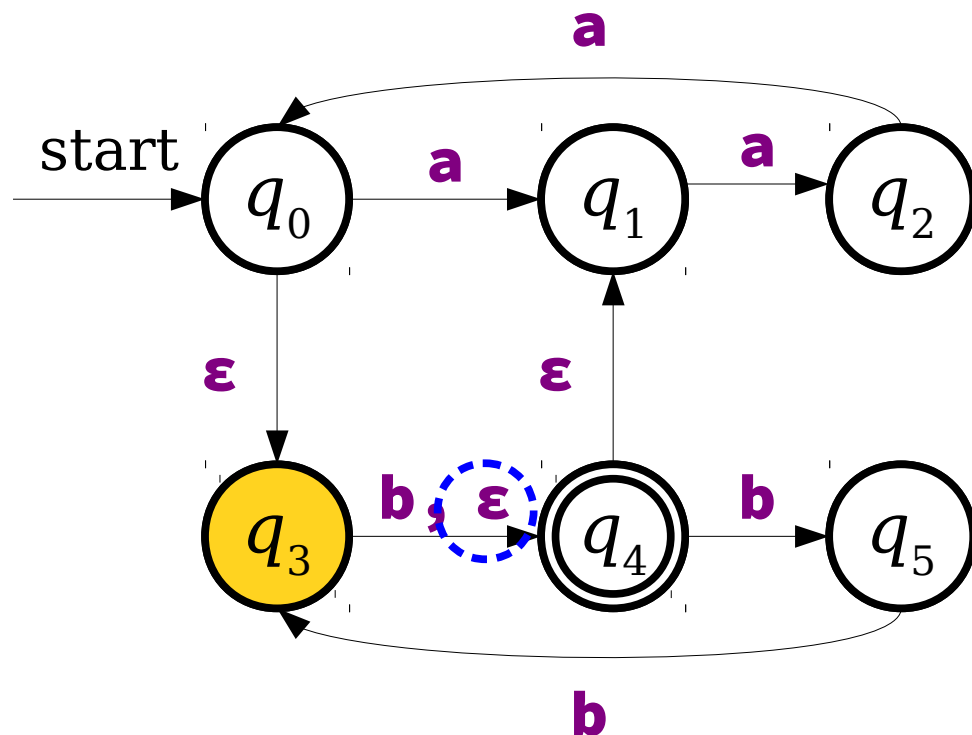

ϵ -Transitions

- NFAs have a special type of transition called the **ϵ -transition**.
- An NFA may follow any number of ϵ -transitions at any time without consuming any input.

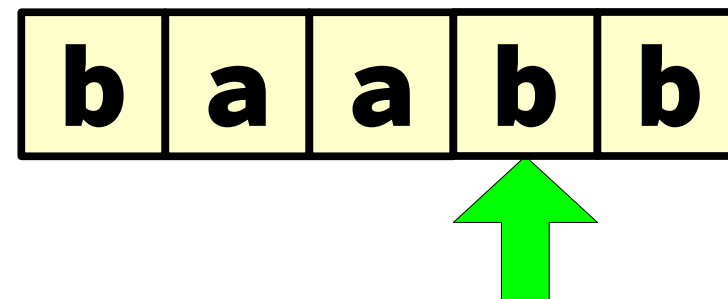
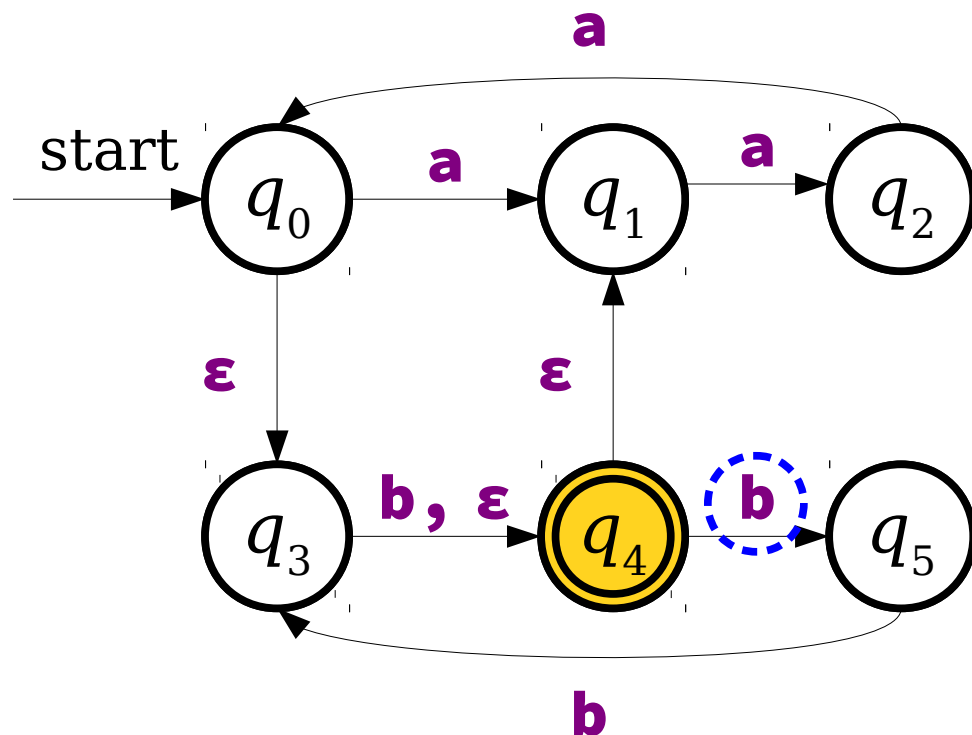

ϵ -Transitions

- NFAs have a special type of transition called the **ϵ -transition**.
- An NFA may follow any number of ϵ -transitions at any time without consuming any input.

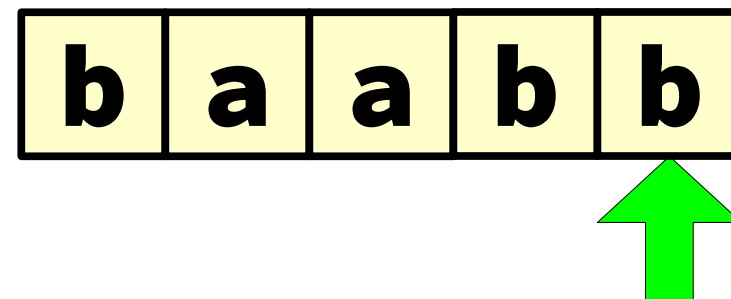
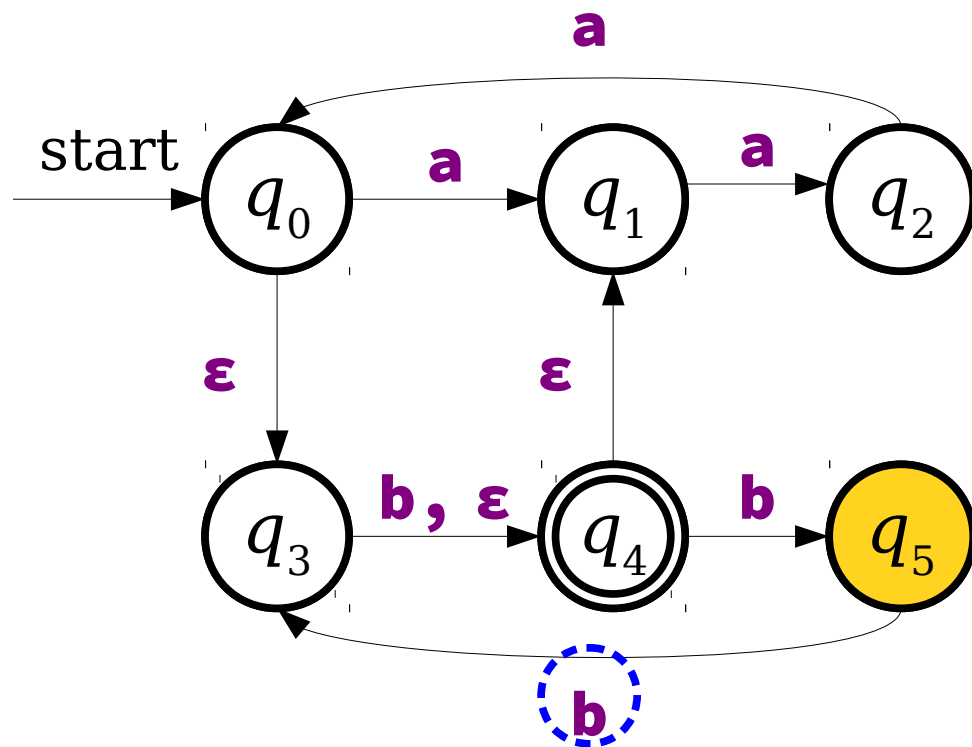

ϵ -Transitions

- NFAs have a special type of transition called the **ϵ -transition**.
- An NFA may follow any number of ϵ -transitions at any time without consuming any input.

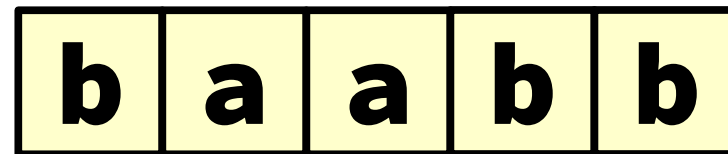
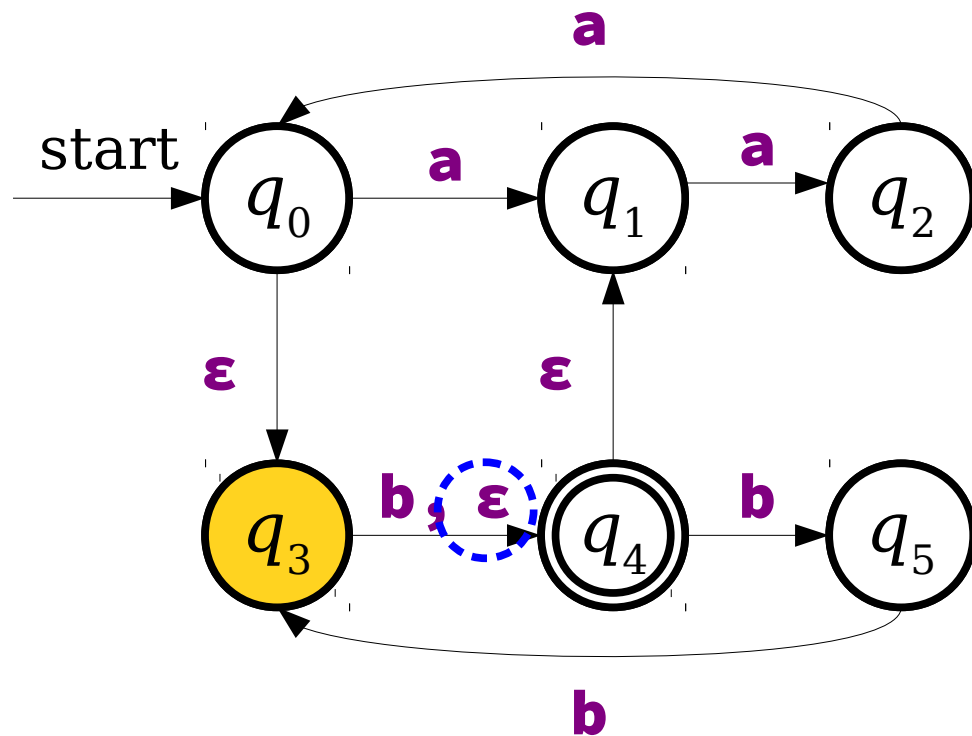

ϵ -Transitions

- NFAs have a special type of transition called the **ϵ -transition**.
- An NFA may follow any number of ϵ -transitions at any time without consuming any input.

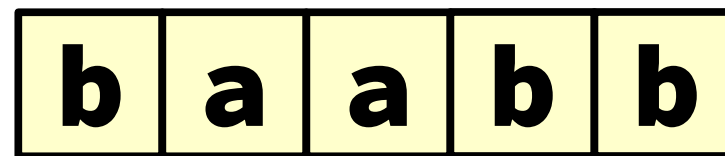
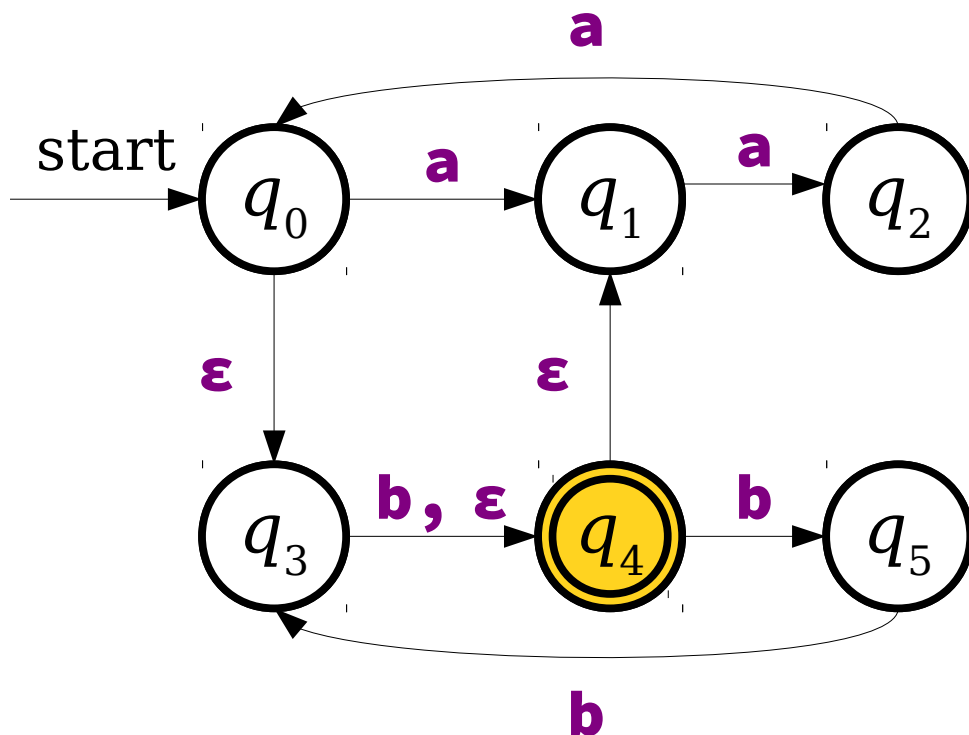

ϵ -Transitions

- NFAs have a special type of transition called the **ϵ -transition**.
- An NFA may follow any number of ϵ -transitions at any time without consuming any input.

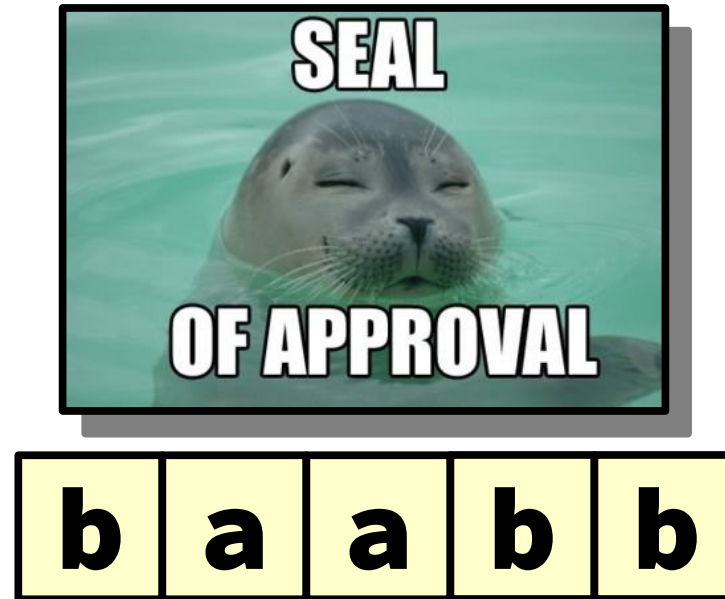
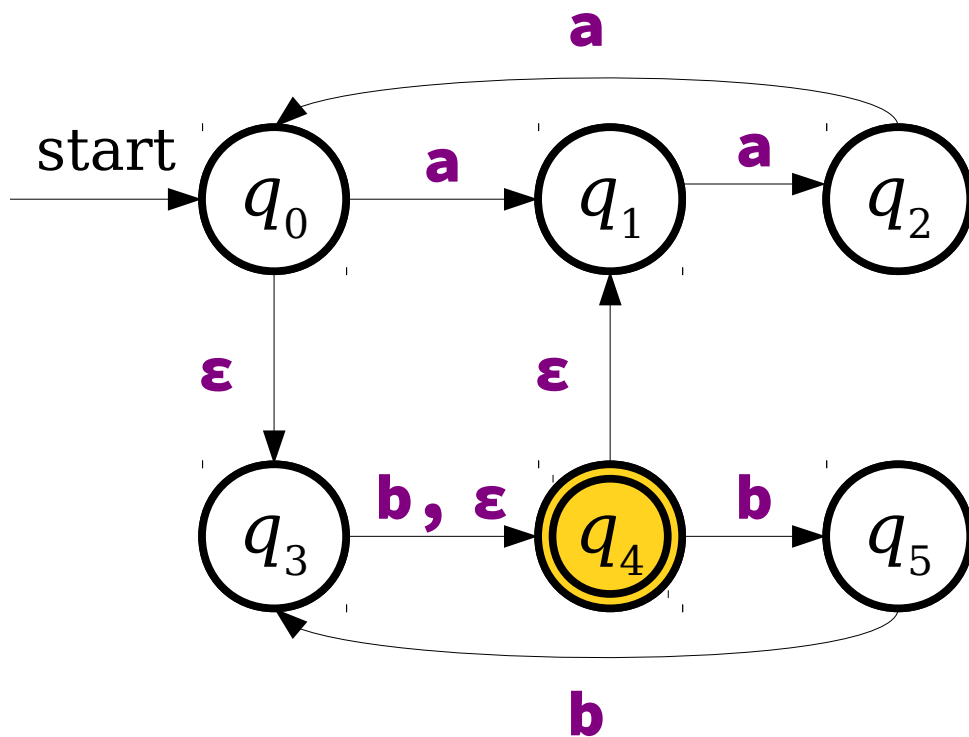

ϵ -Transitions

- NFAs have a special type of transition called the **ϵ -transition**.
- An NFA may follow any number of ϵ -transitions at any time without consuming any input.

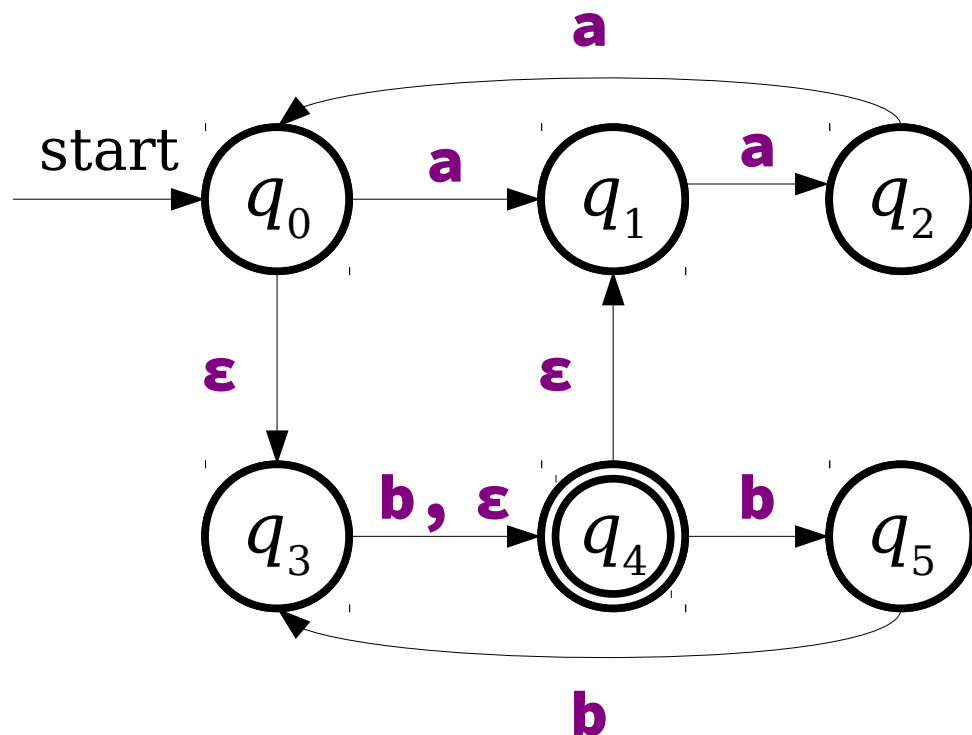

Not at all fun or rewarding exercise: what is the language of this NFA?

ϵ -Transitions

- NFAs have a special type of transition called the **ϵ -transition**.
- An NFA may follow any number of ϵ -transitions at any time without consuming any input.
- NFAs are not *required* to follow ϵ -transitions. It's simply another option at the machine's disposal.

Intuiting Nondeterminism

- Nondeterministic machines are a serious departure from physical computers. How can we build up an intuition for them?
- There are two particularly useful frameworks for interpreting nondeterminism:
 - *Perfect positive guessing*
 - *Massive parallelism*

Perfect Positive Guessing

Σ

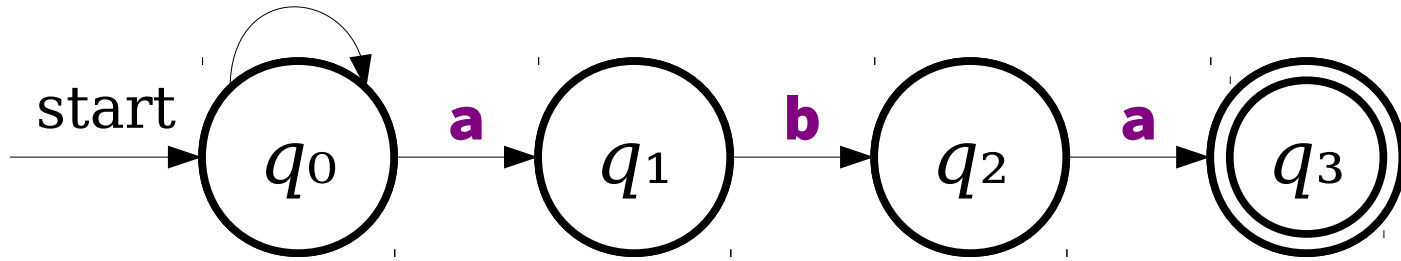

Perfect Positive Guessing

Σ

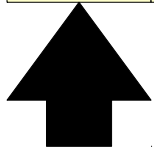
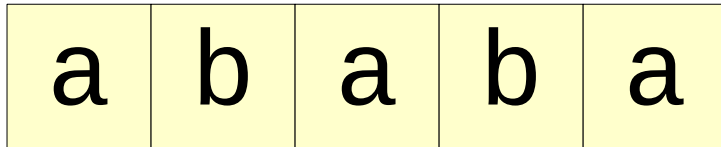
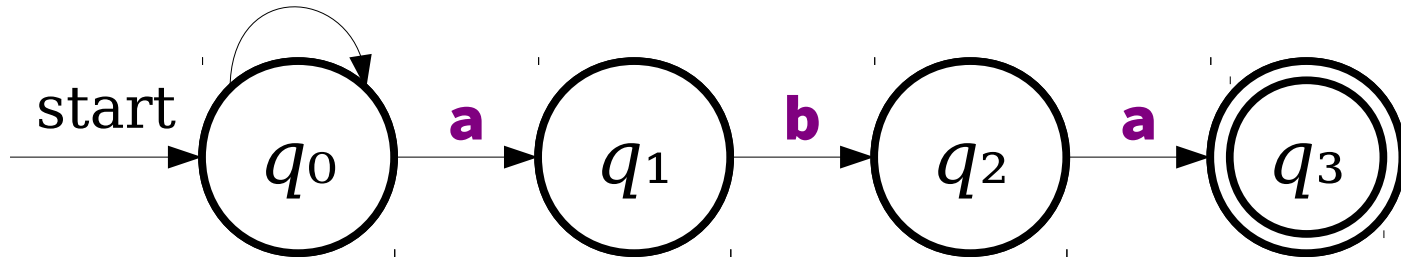

Perfect Positive Guessing

Σ

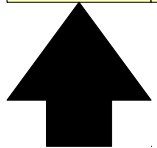
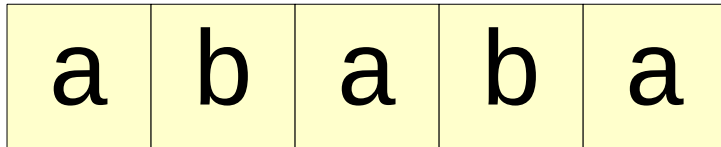
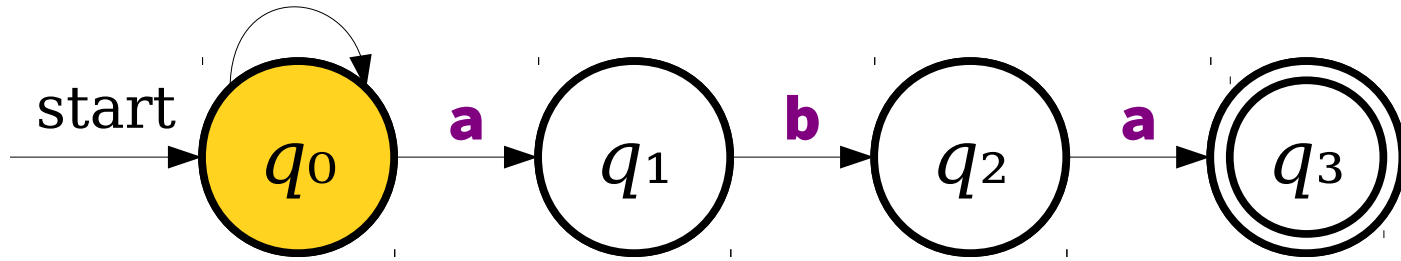

Perfect Positive Guessing

Σ

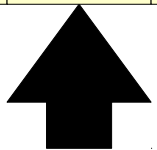
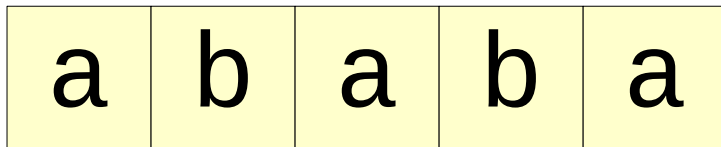
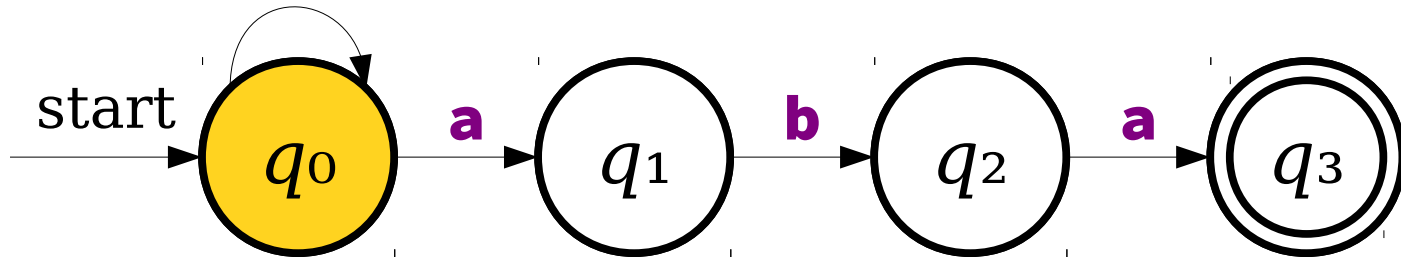

Perfect Positive Guessing

Σ

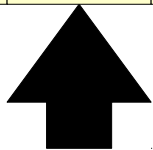
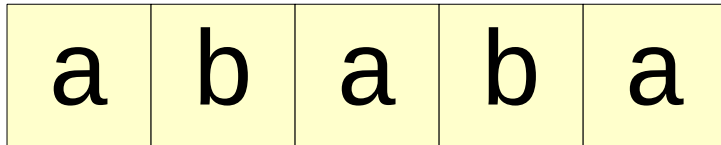
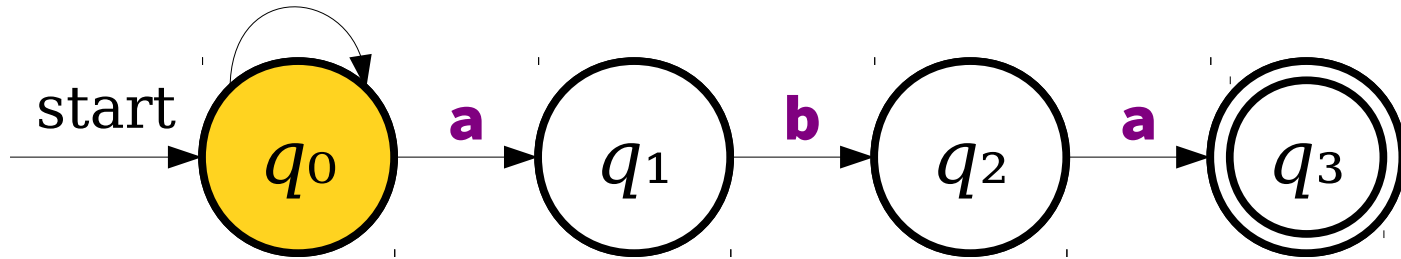

Perfect Positive Guessing

Σ

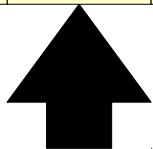
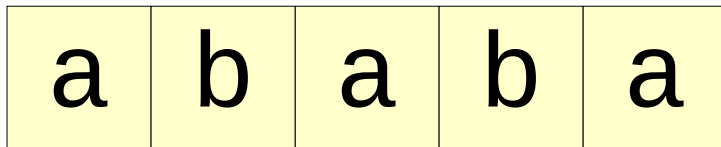
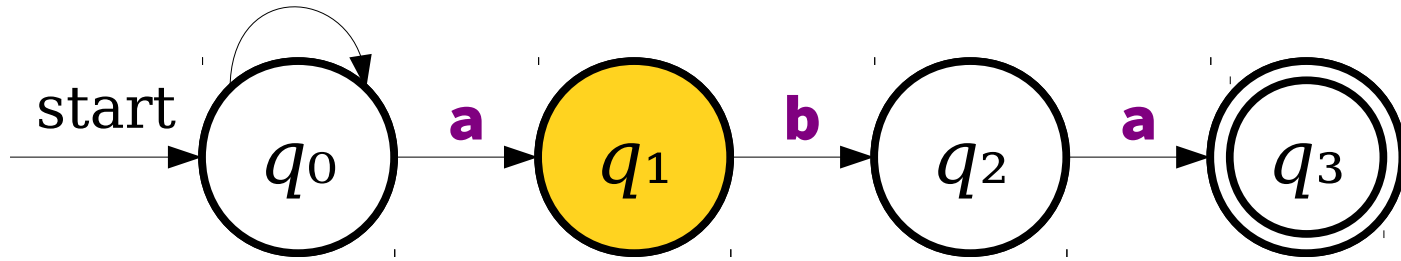

Perfect Positive Guessing

Σ

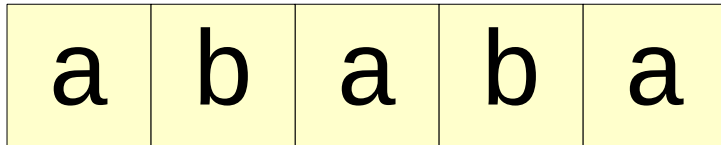
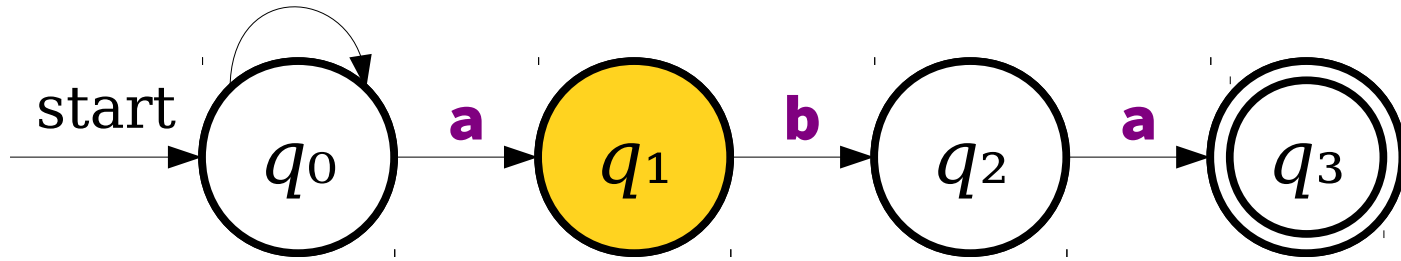

Perfect Positive Guessing

Σ

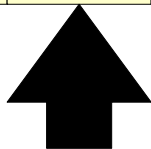
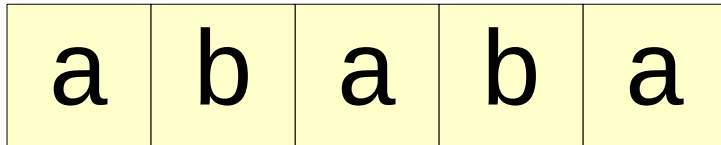
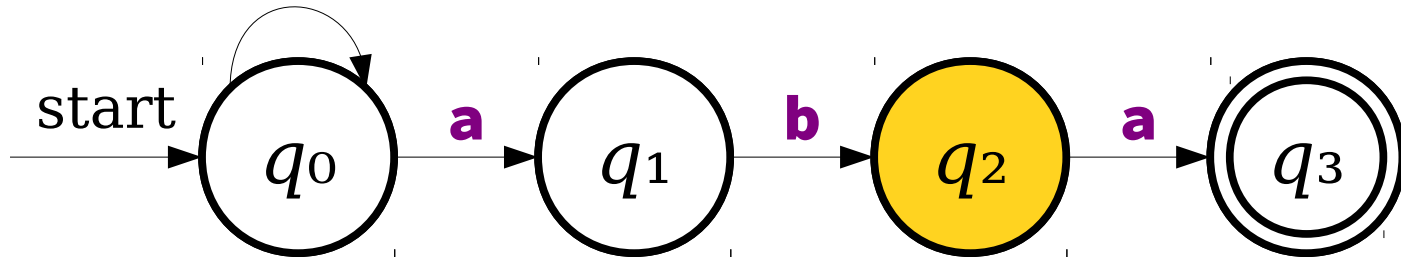

Perfect Positive Guessing

Σ

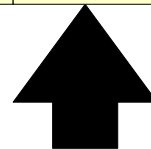
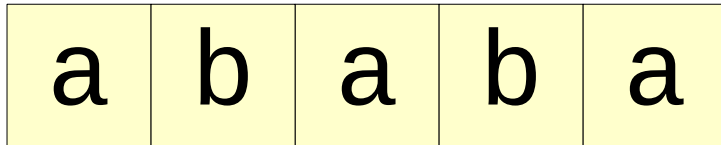
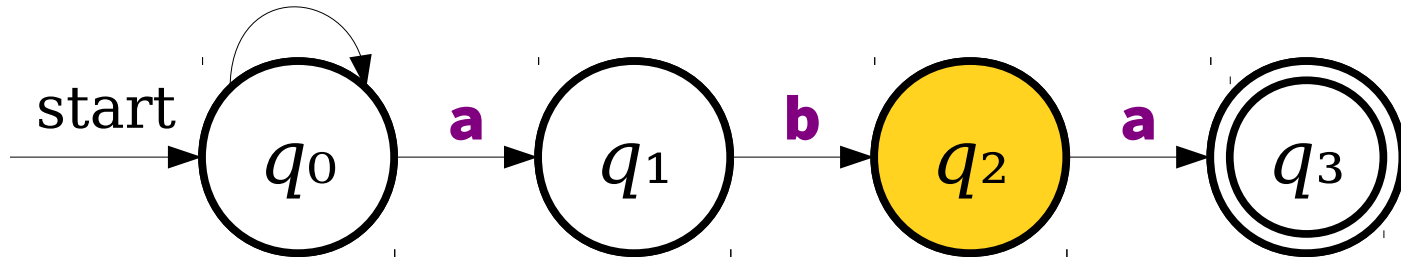

Perfect Positive Guessing

Σ

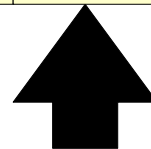
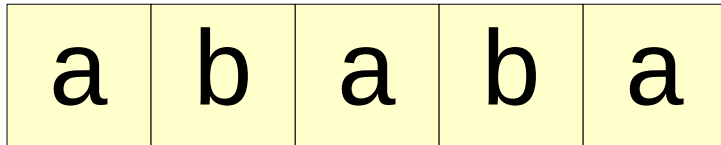
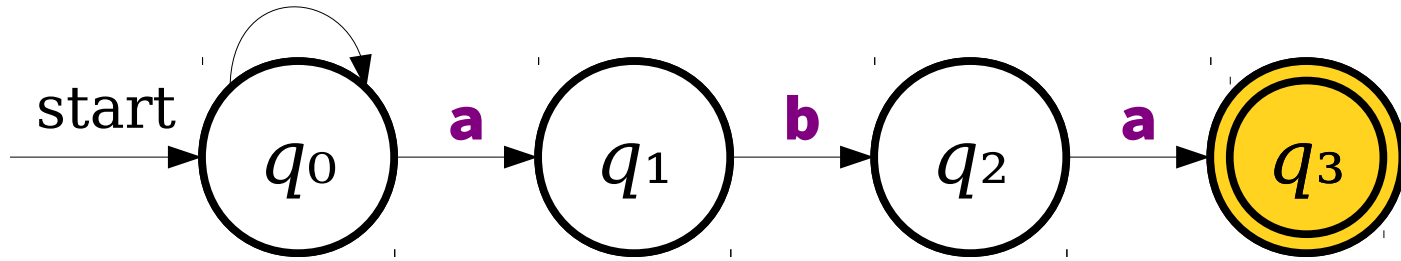

Perfect Positive Guessing

Σ

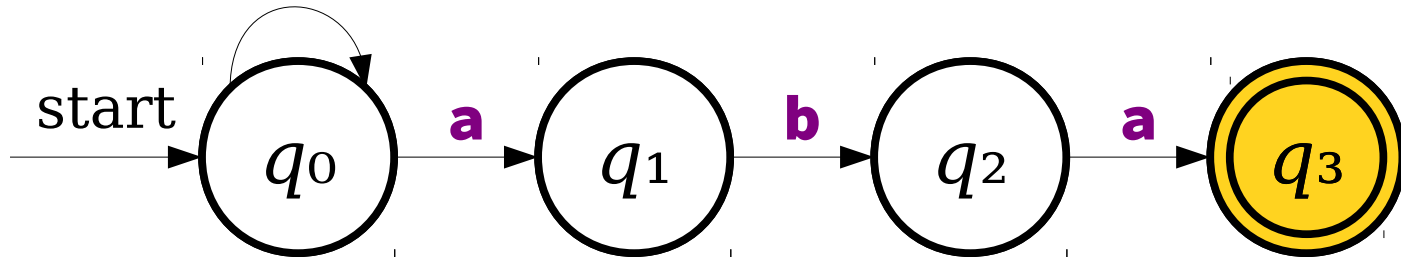

a	b	a	b	a
---	---	---	---	---



Perfect Positive Guessing

- We can view nondeterministic machines as having *Magic Superpowers* that enable them to guess choices that lead to an accepting state.
 - If there is at least one choice that leads to an accepting state, the machine will guess it.
 - If there are no choices, the machine guesses any one of the wrong guesses.
- There is no known way to physically model this intuition of nondeterminism – this is quite a departure from reality!

Massive Parallelism

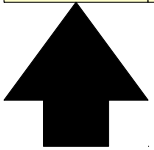
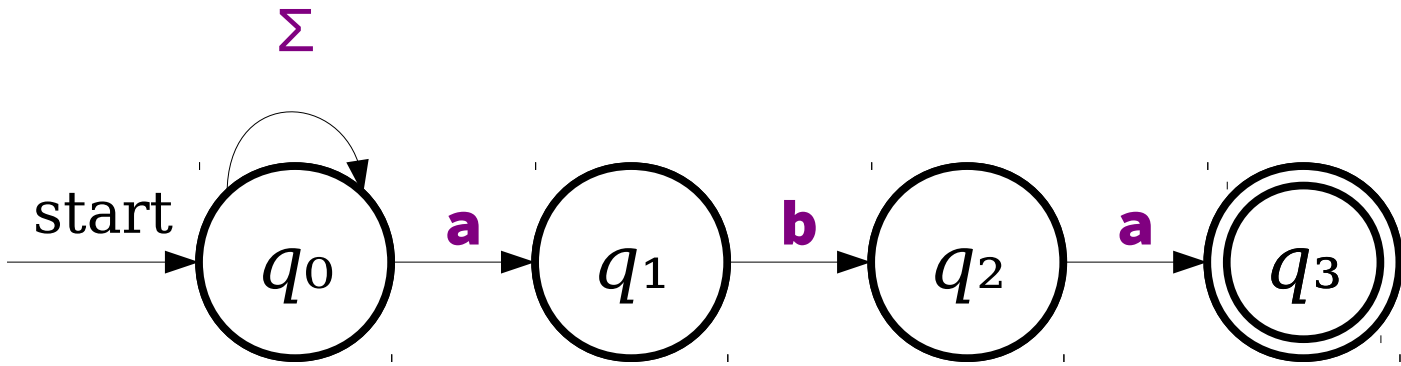

Massive Parallelism

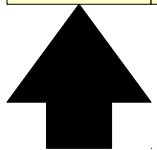
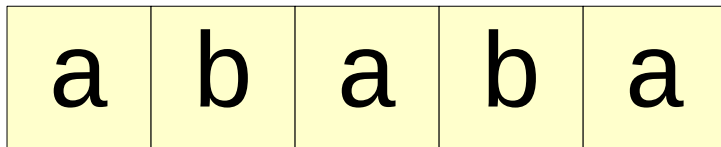
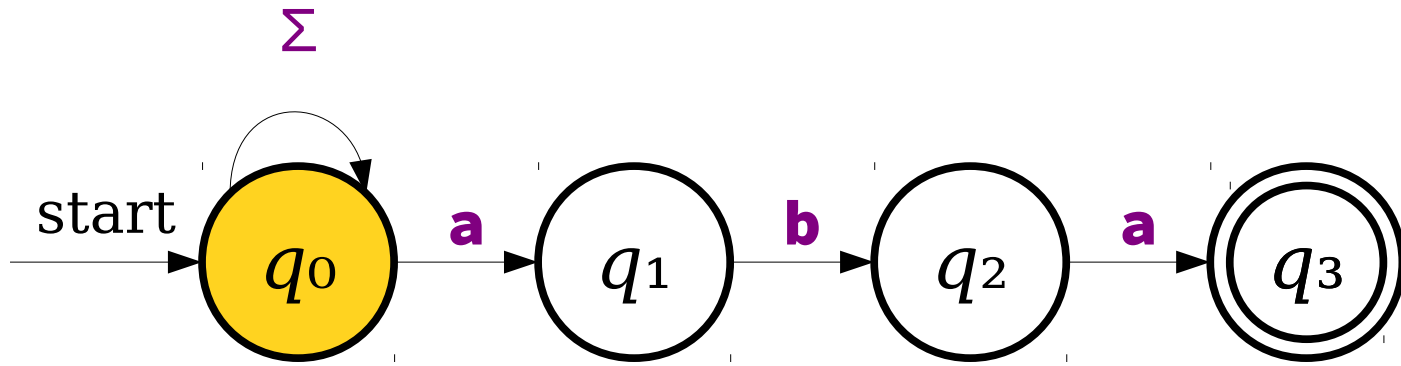

Massive Parallelism

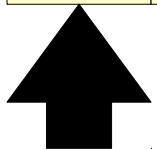
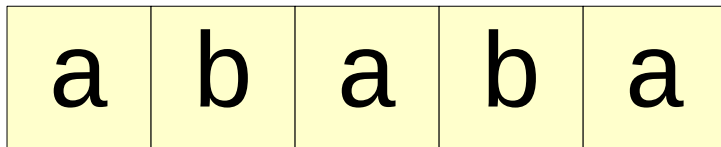
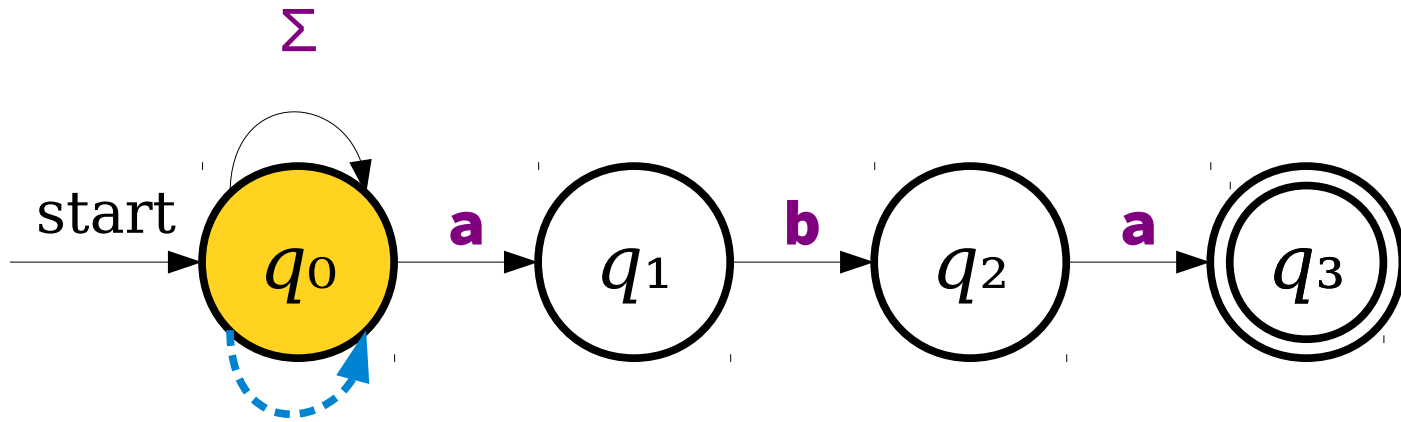

Massive Parallelism

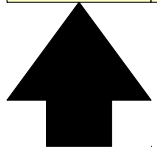
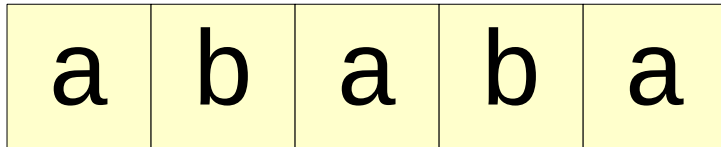
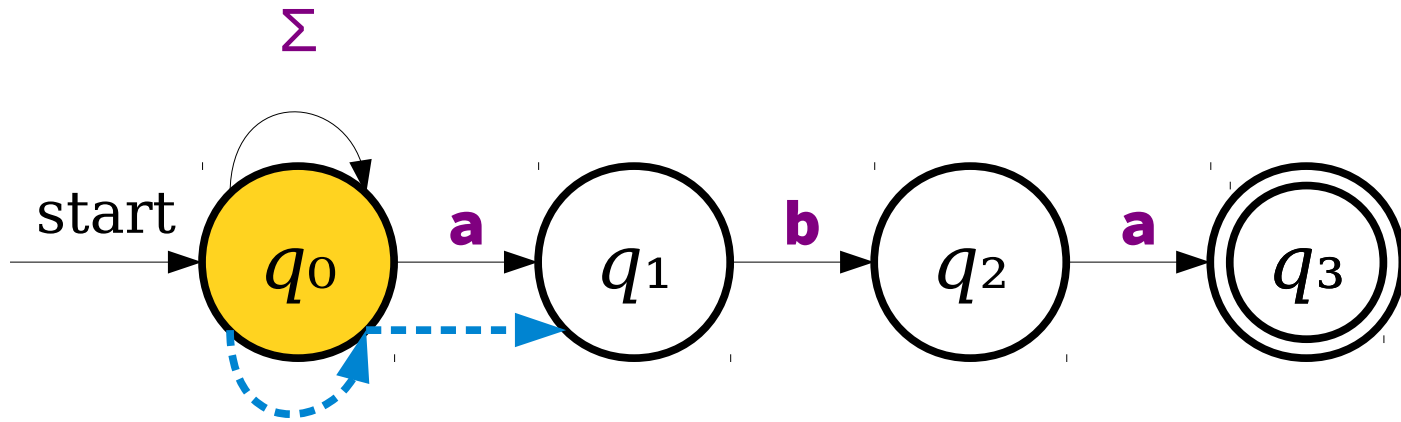

Massive Parallelism

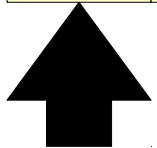
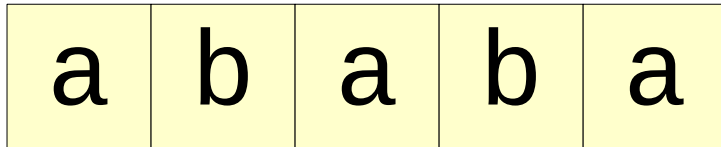
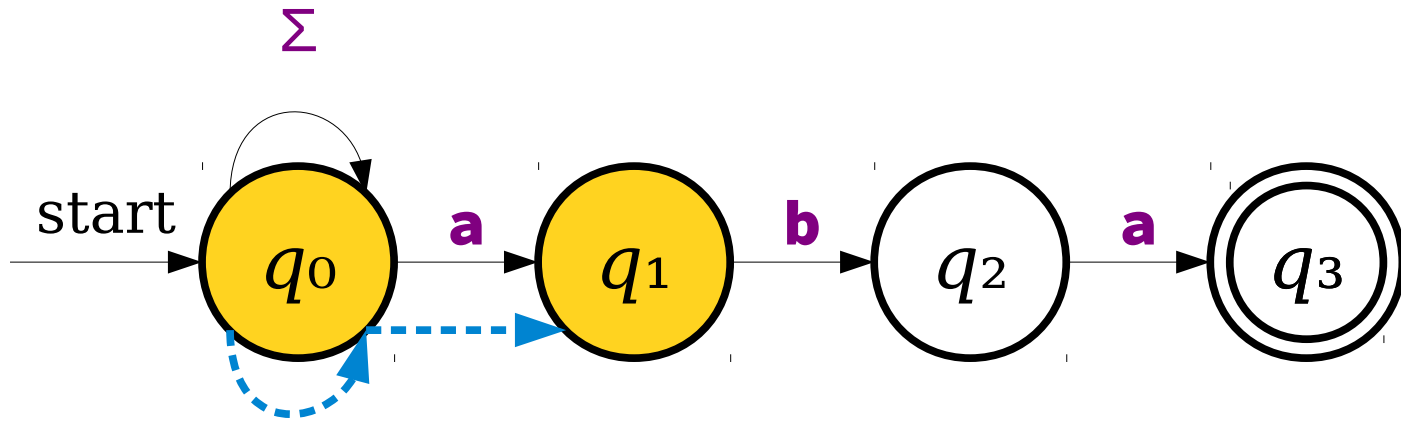

Massive Parallelism

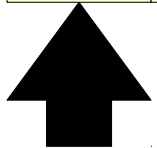
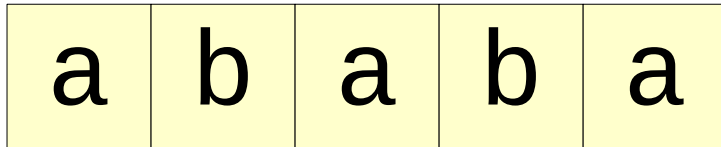
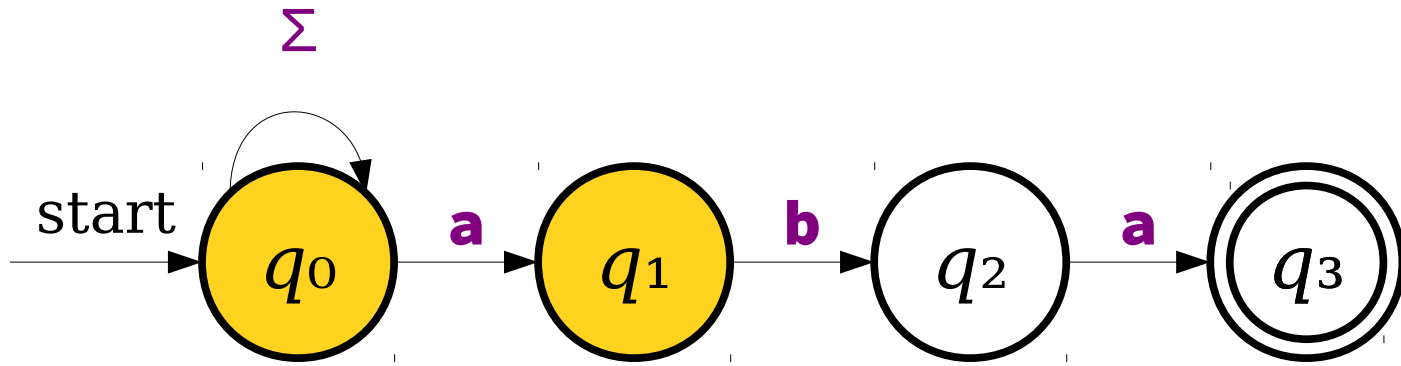

Massive Parallelism

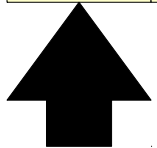
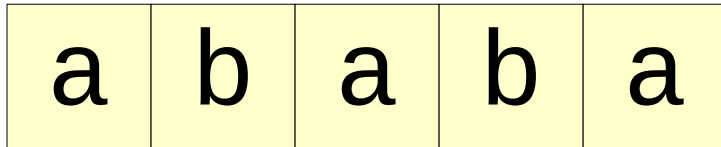
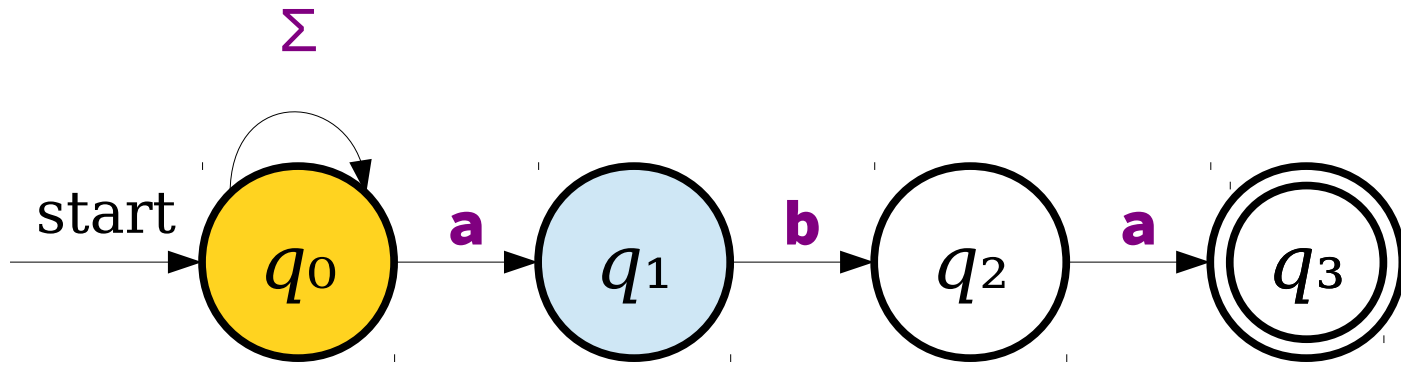

Massive Parallelism

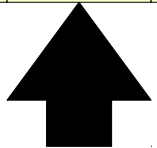
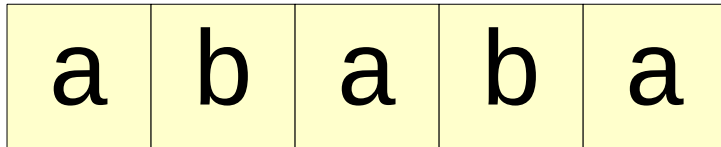
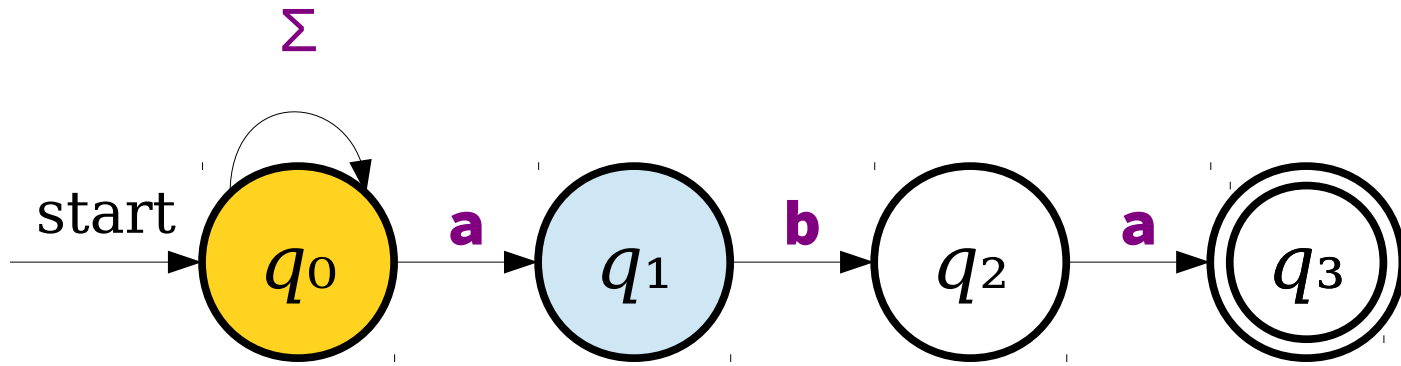

Massive Parallelism

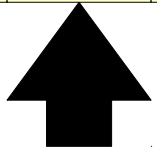
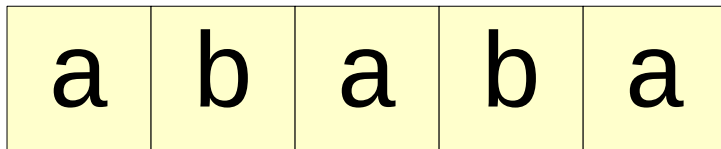
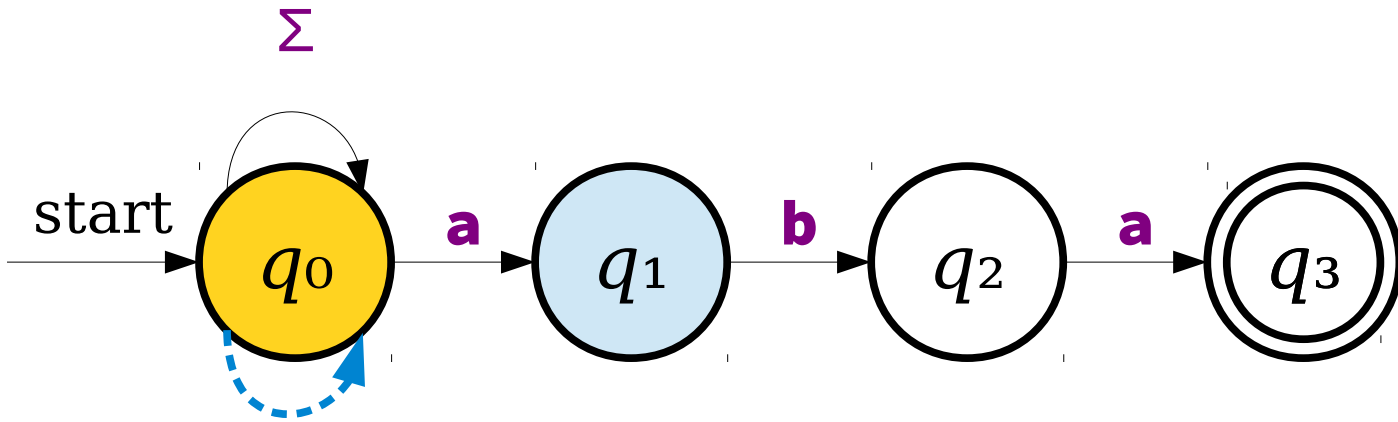

Massive Parallelism

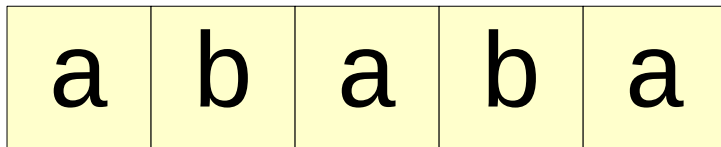
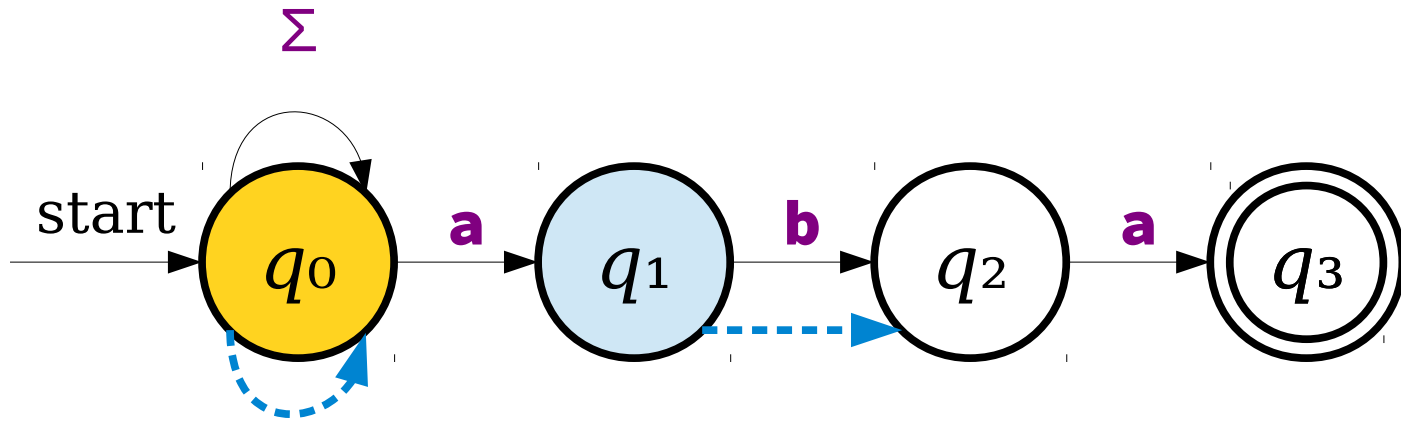

Massive Parallelism

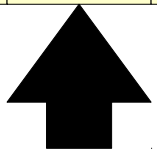
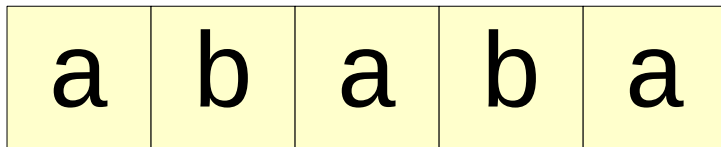
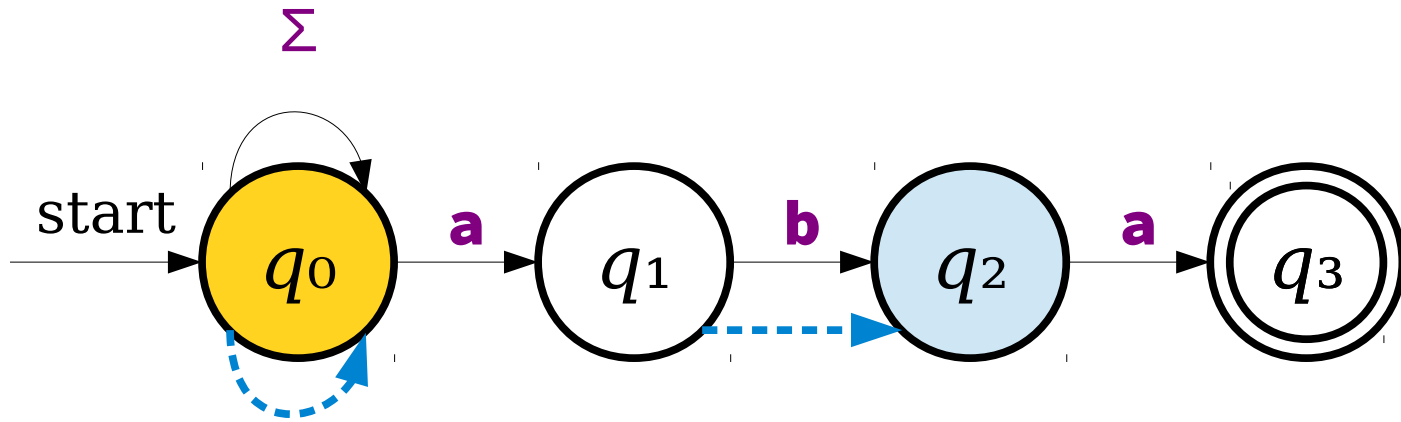

Massive Parallelism

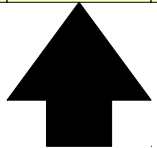
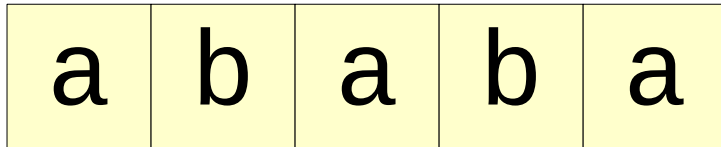
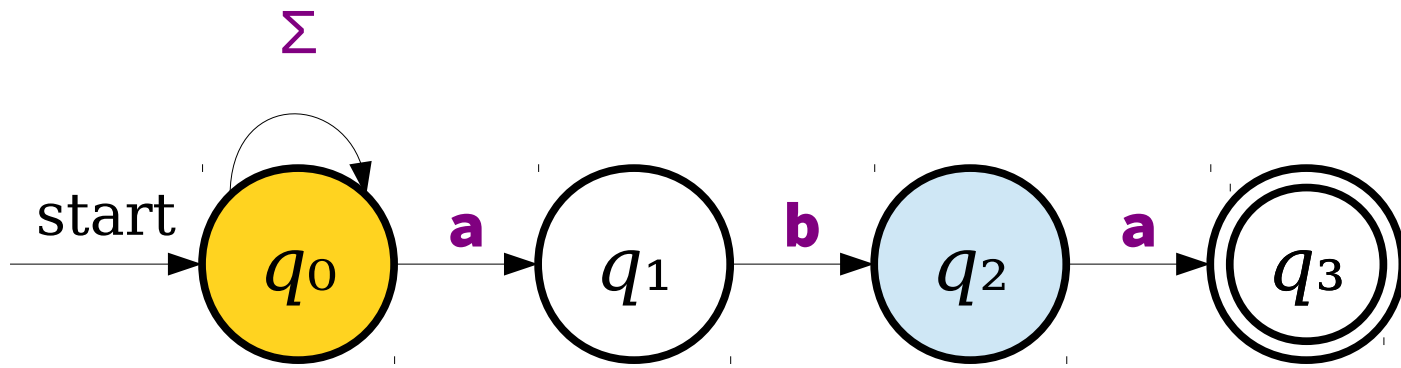

Massive Parallelism

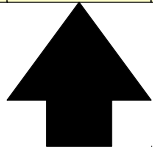
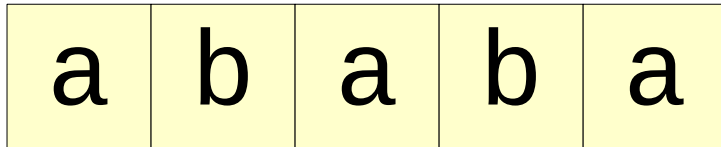
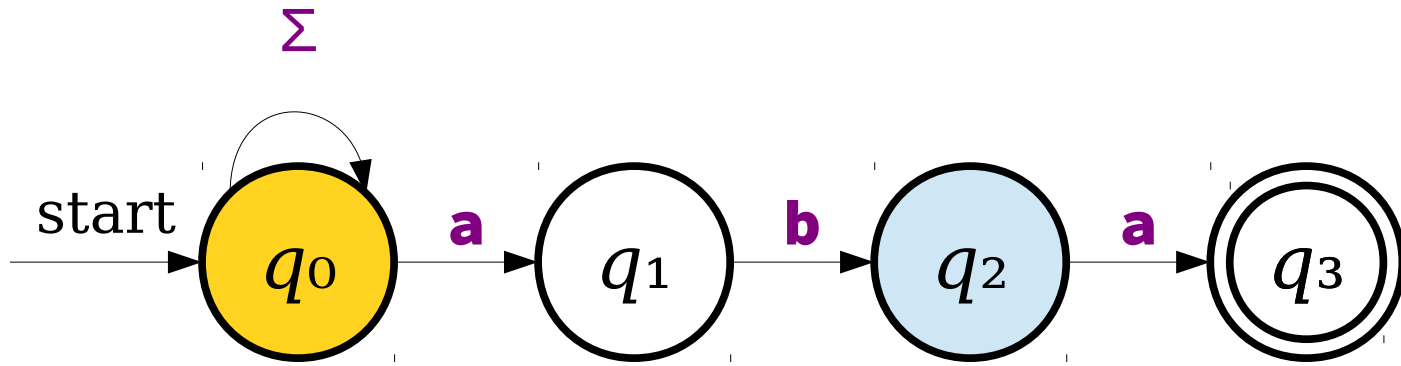

Massive Parallelism

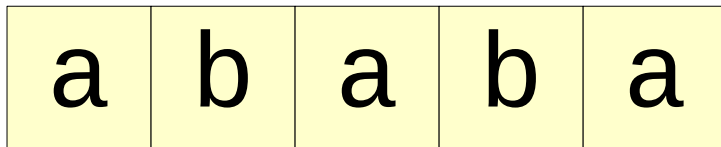
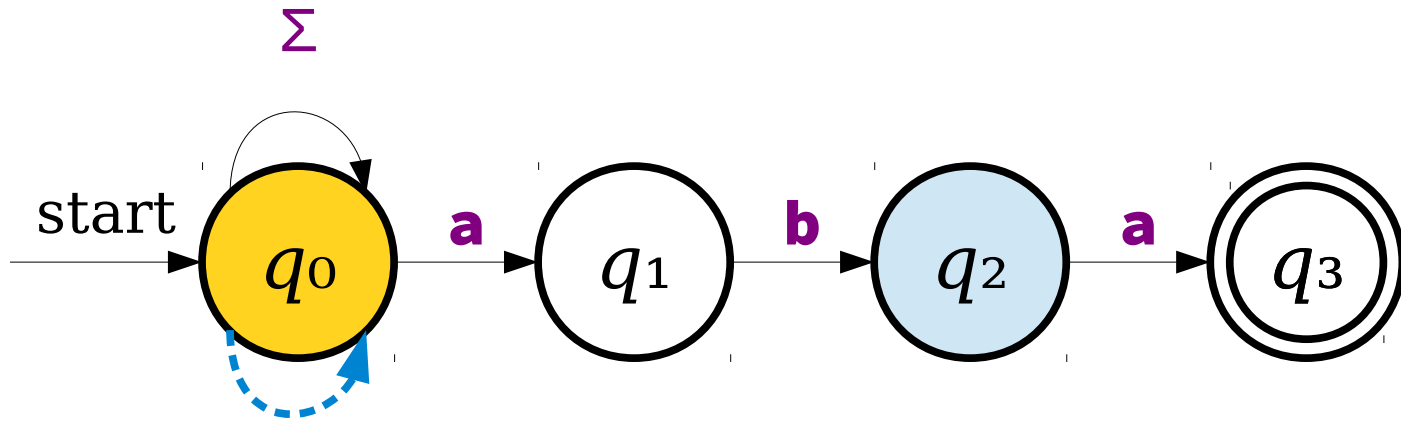

Massive Parallelism

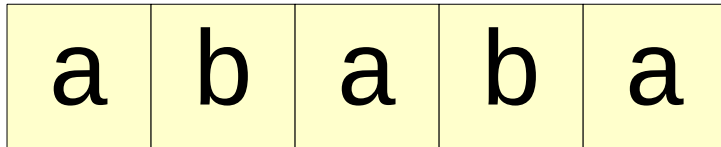
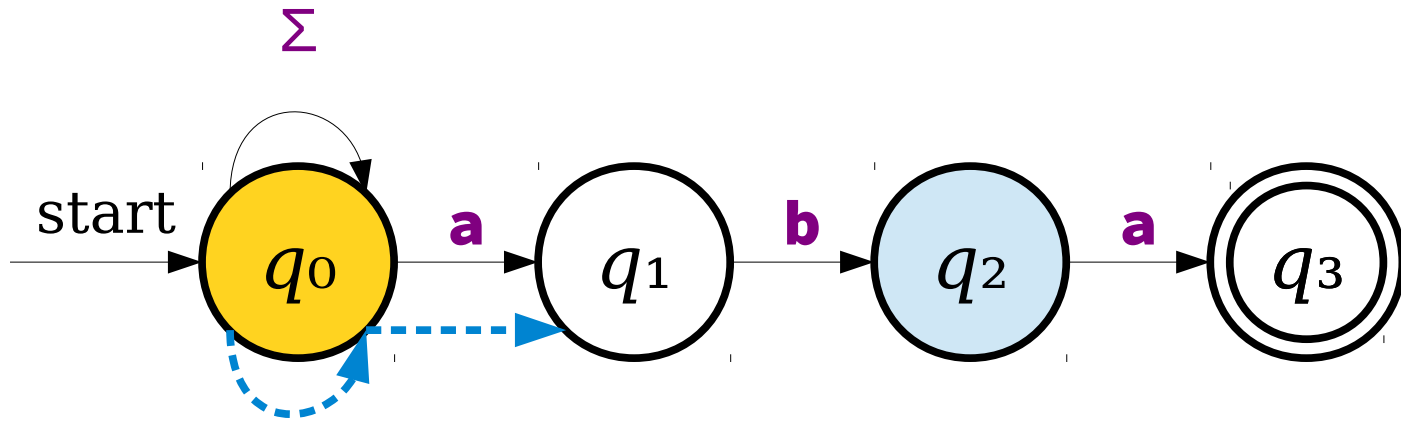

Massive Parallelism

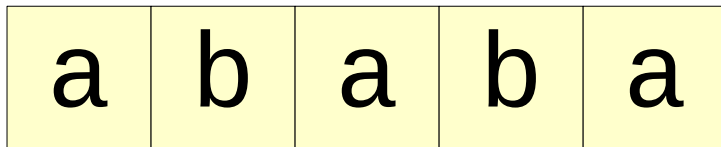
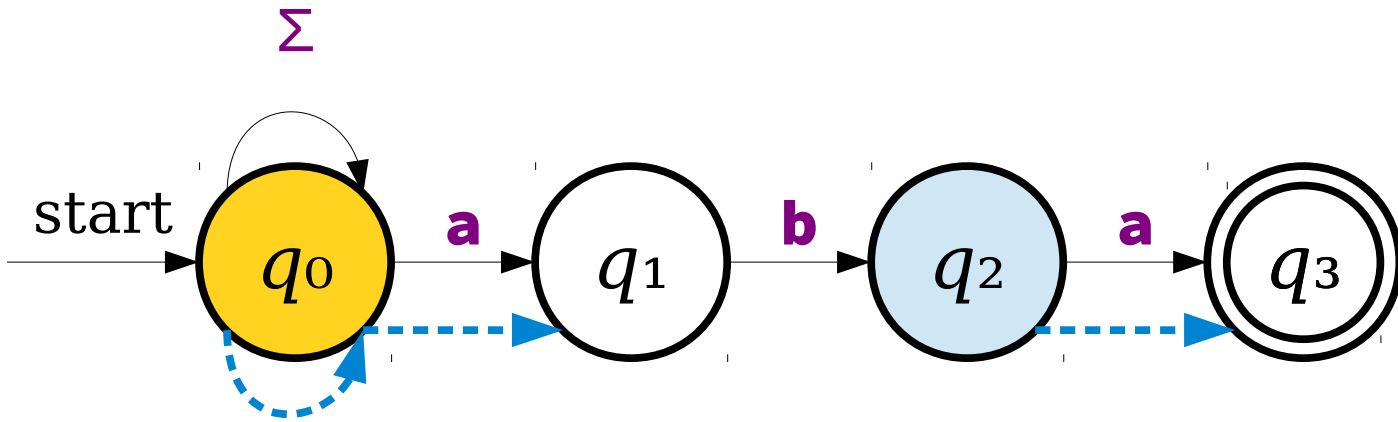

Massive Parallelism

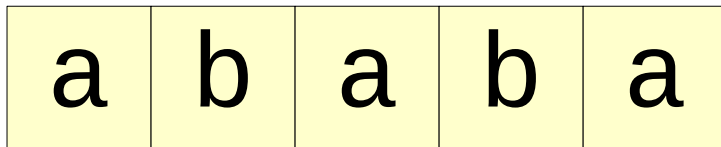
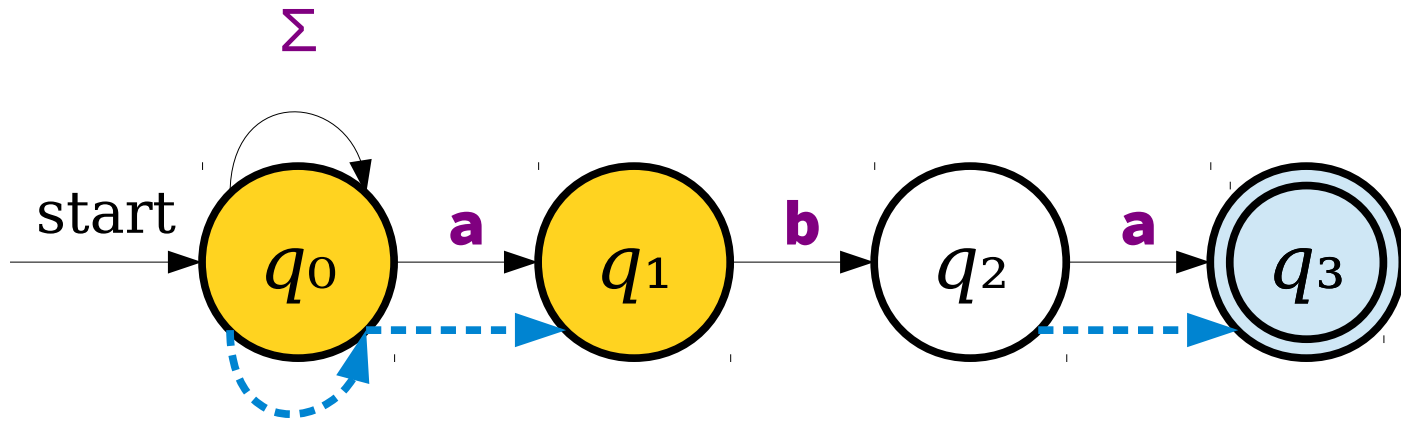

Massive Parallelism

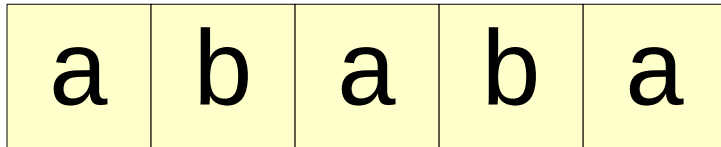
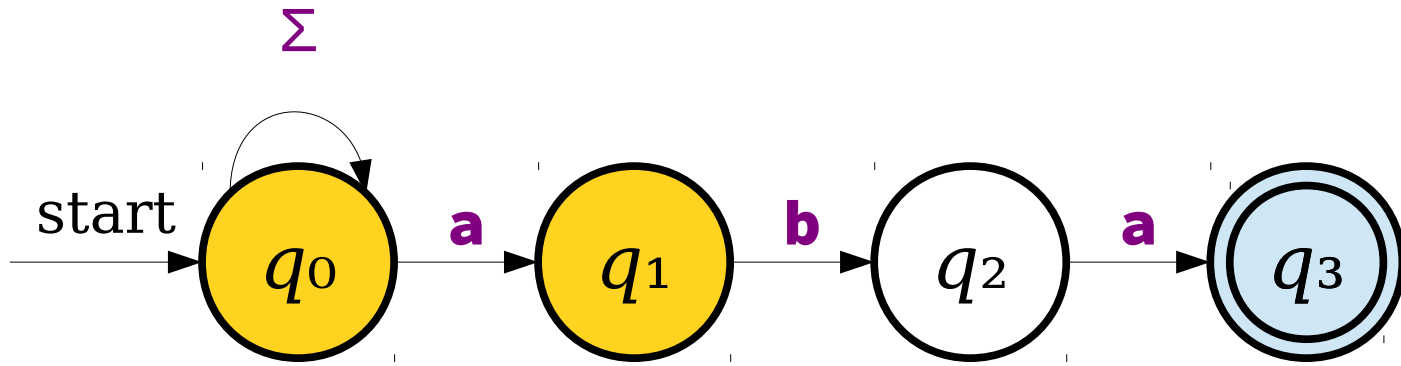

Massive Parallelism

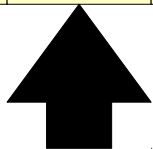
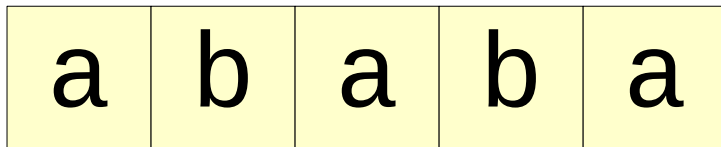
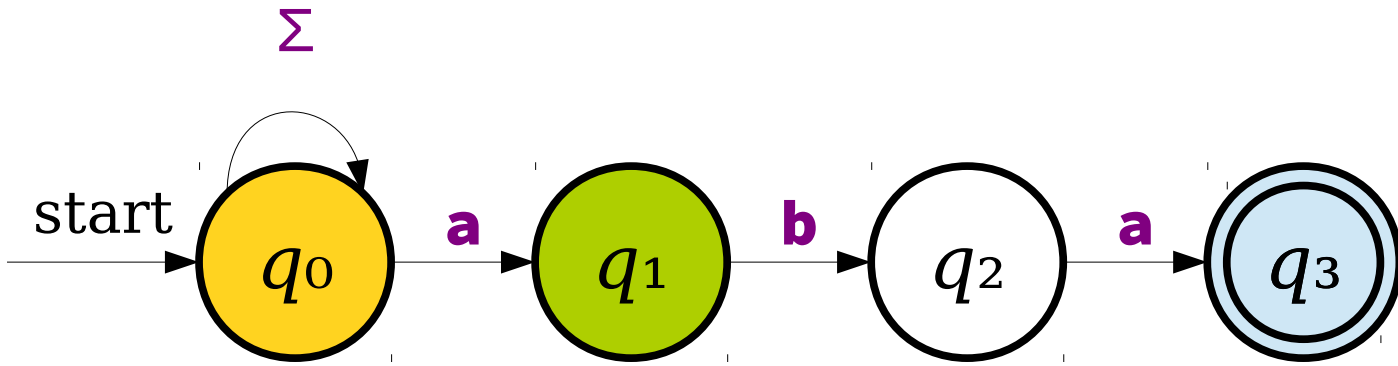

Massive Parallelism

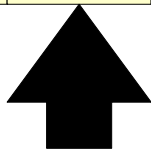
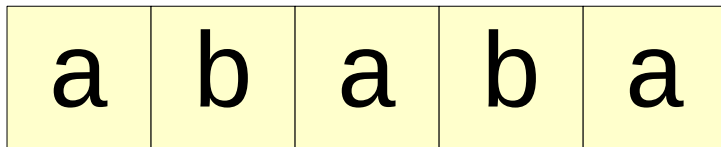
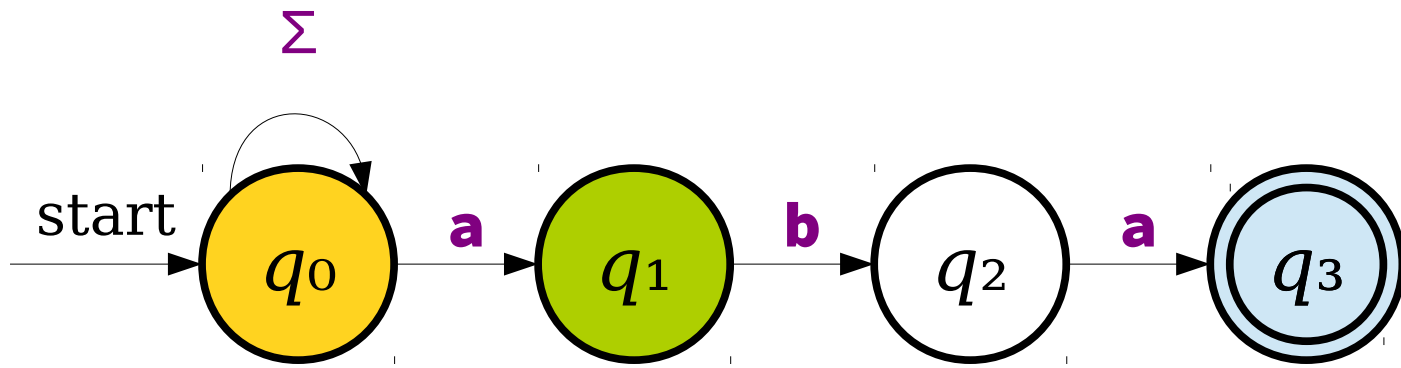

Massive Parallelism

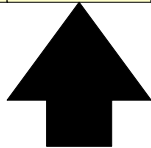
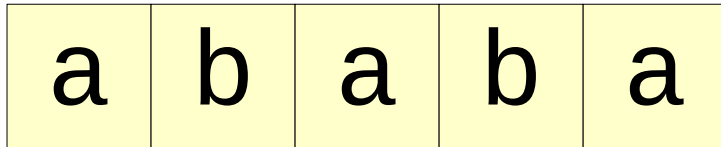
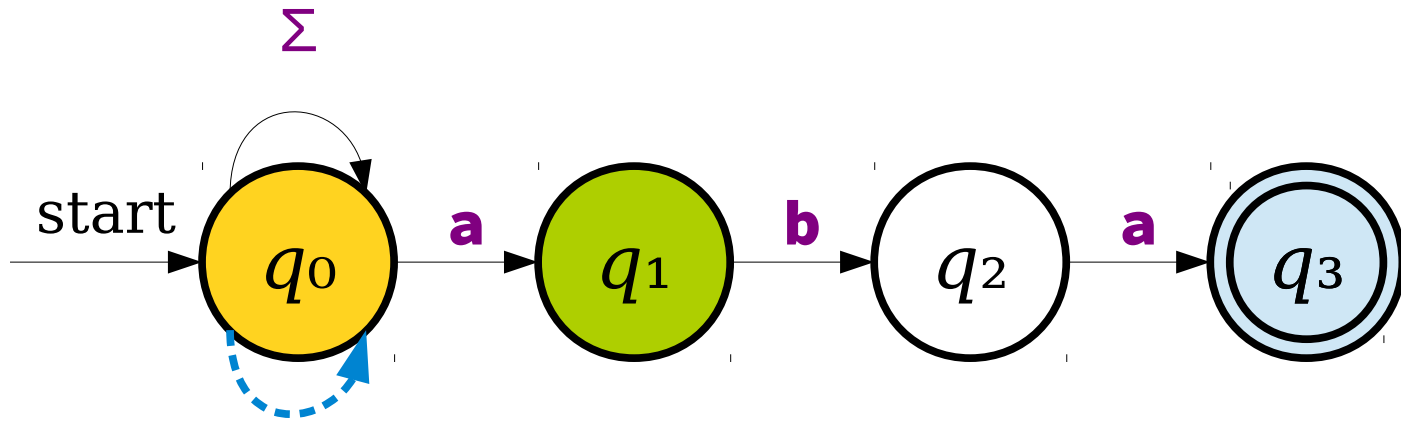

Massive Parallelism

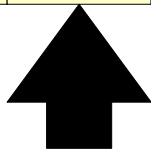
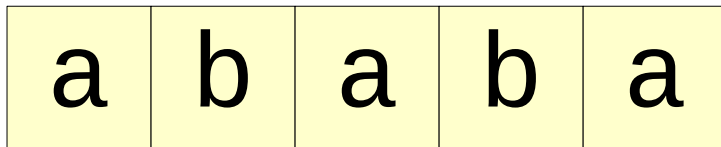
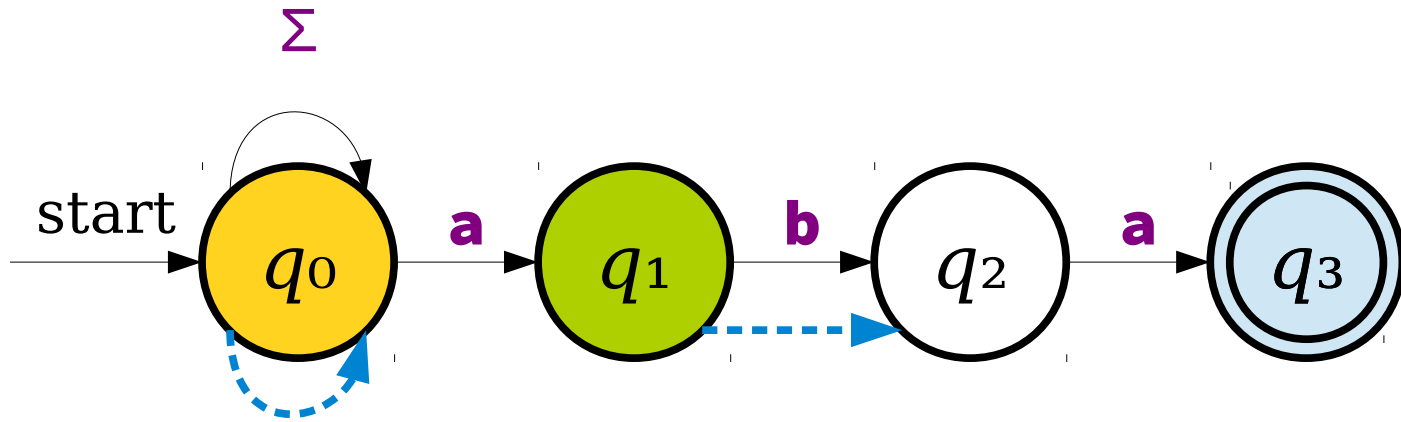

Massive Parallelism

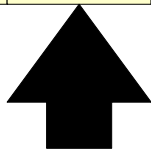
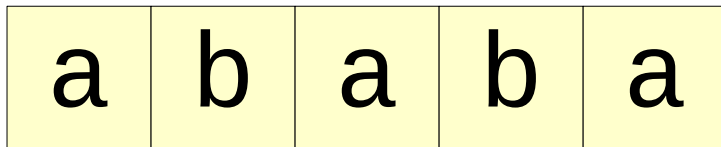
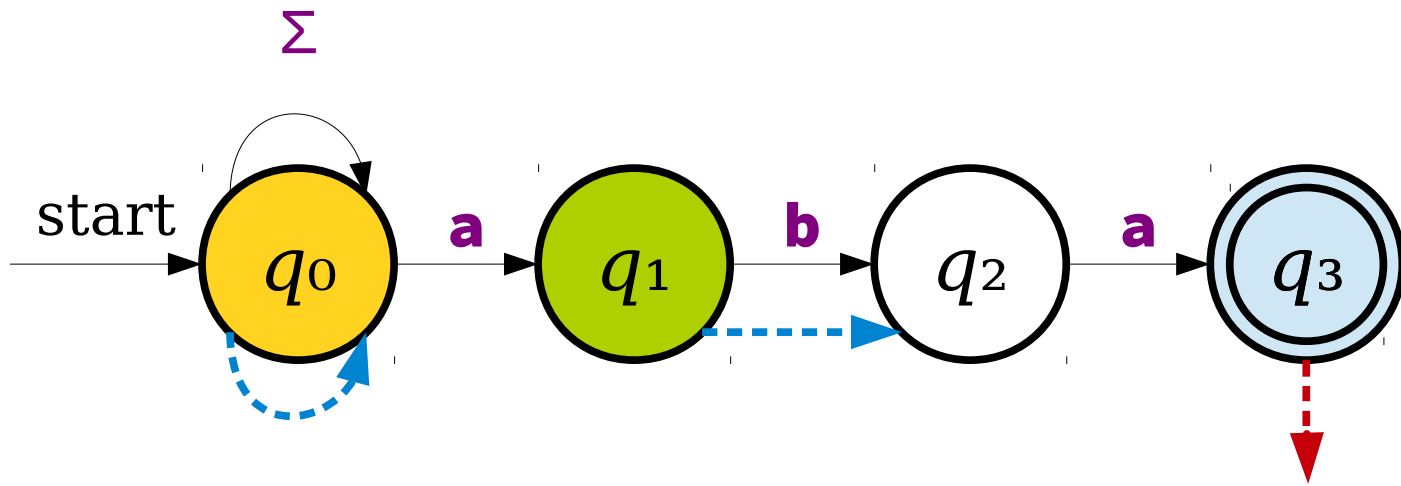

Massive Parallelism

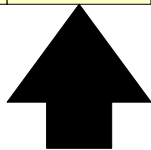
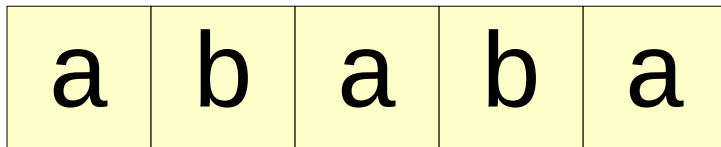
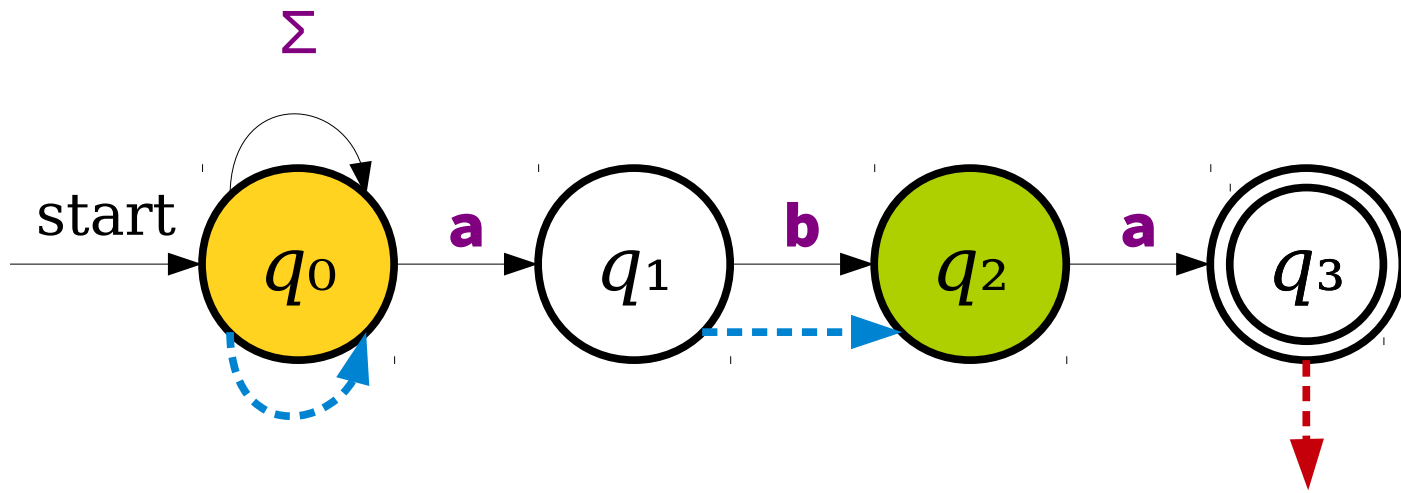

Massive Parallelism

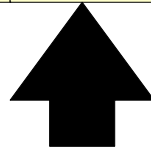
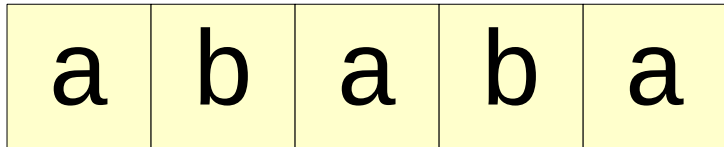
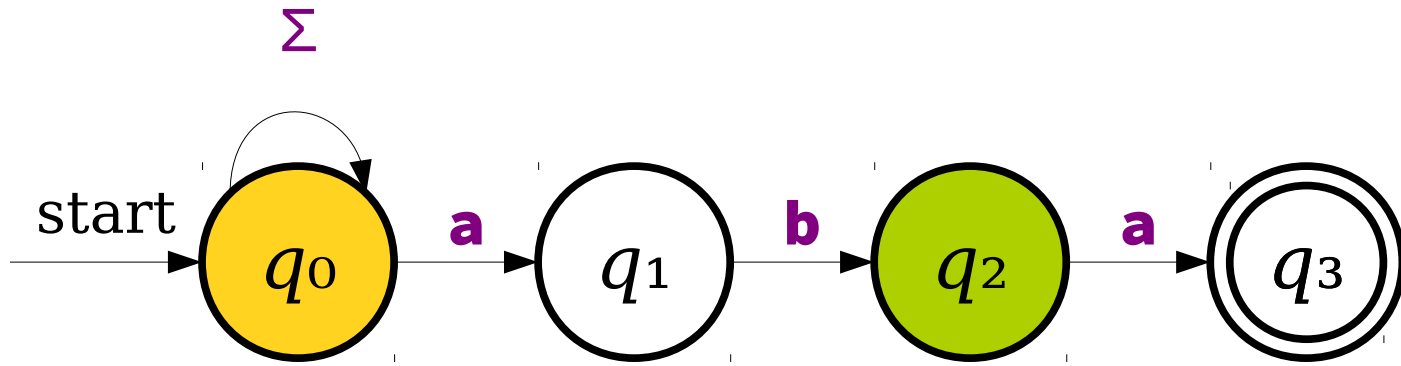

Massive Parallelism

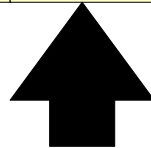
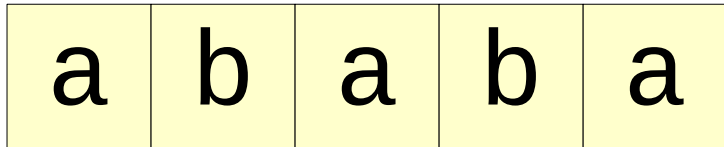
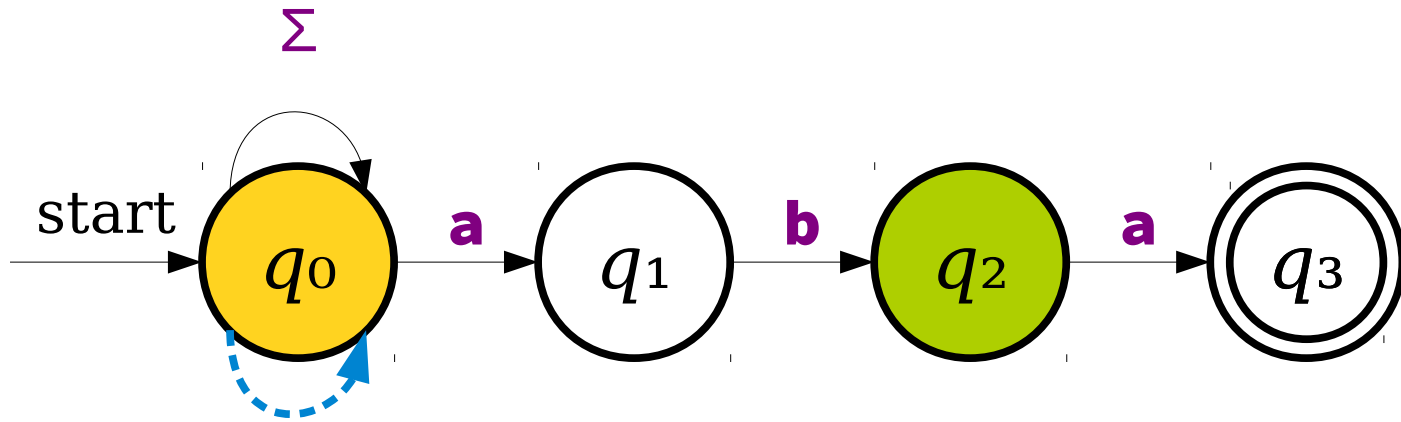

Massive Parallelism

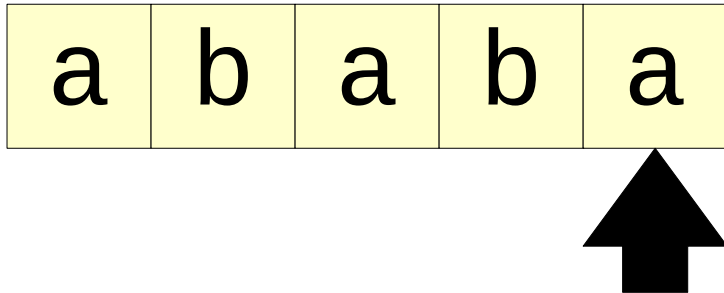
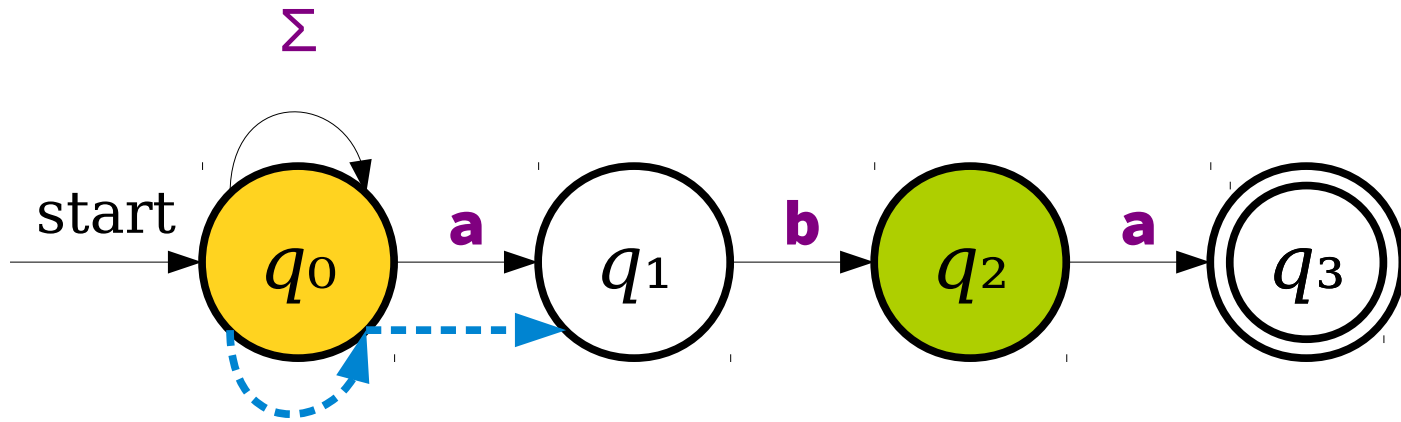

Massive Parallelism

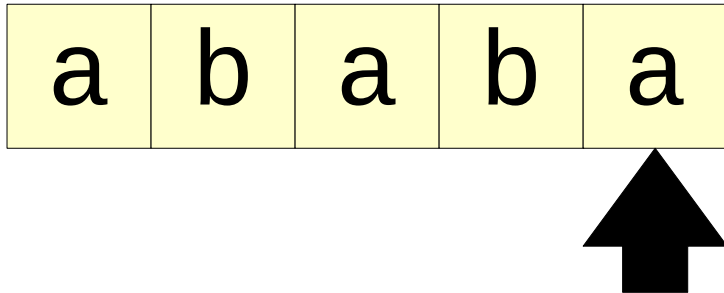
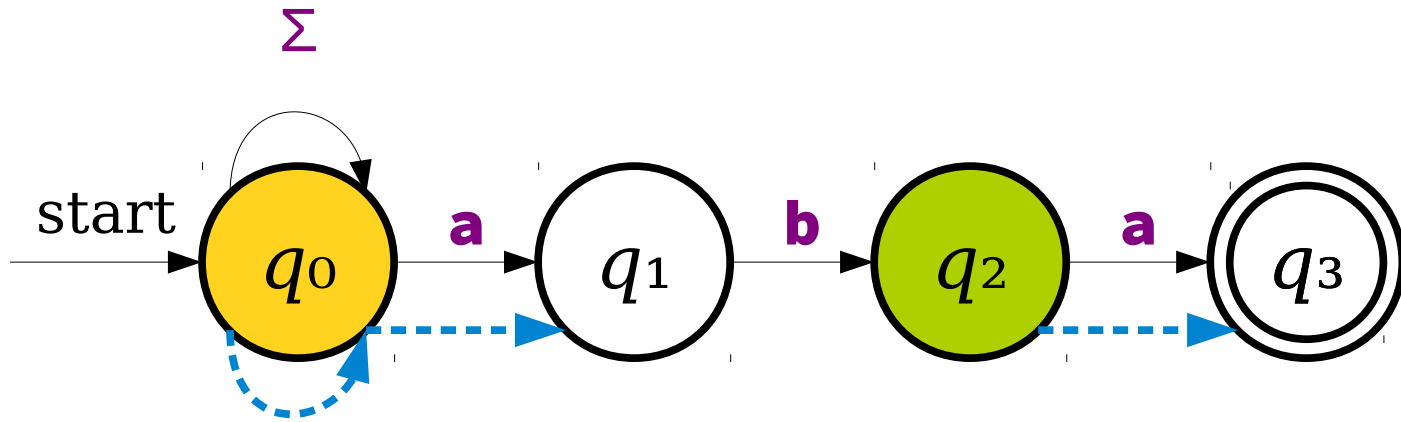

Massive Parallelism

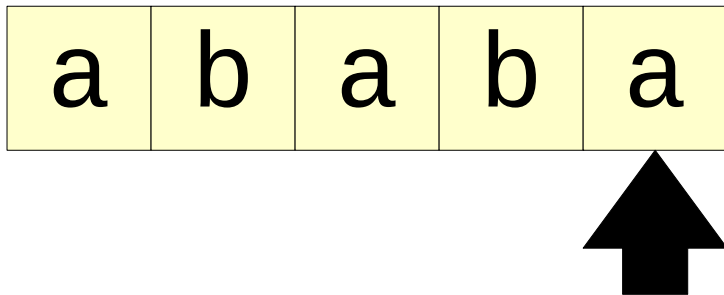
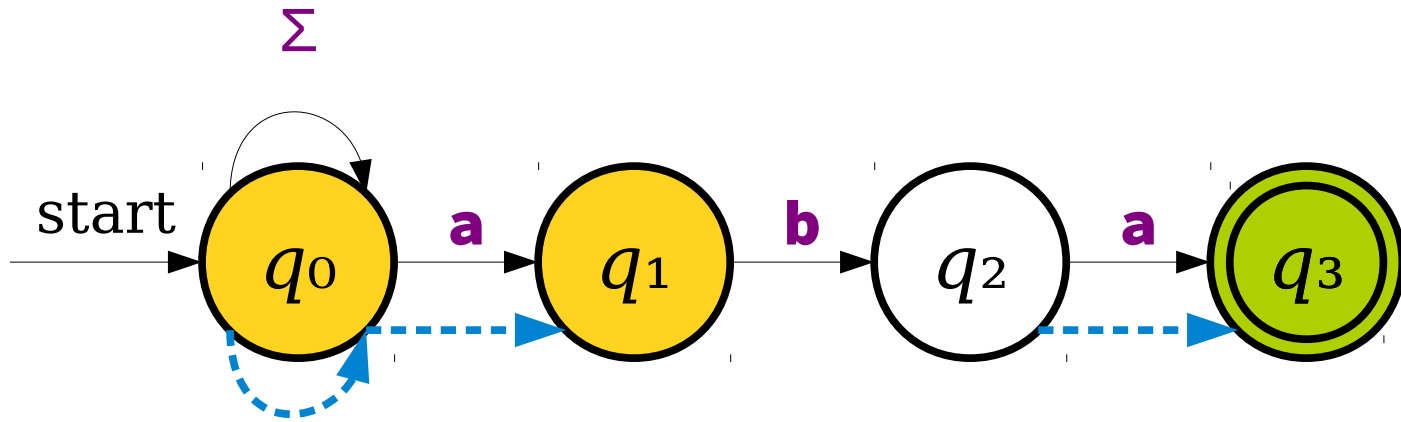

Massive Parallelism

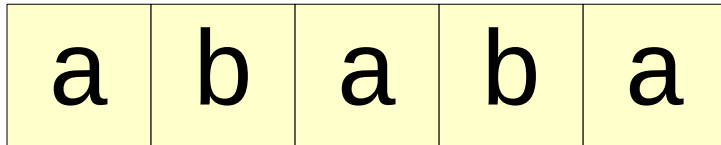
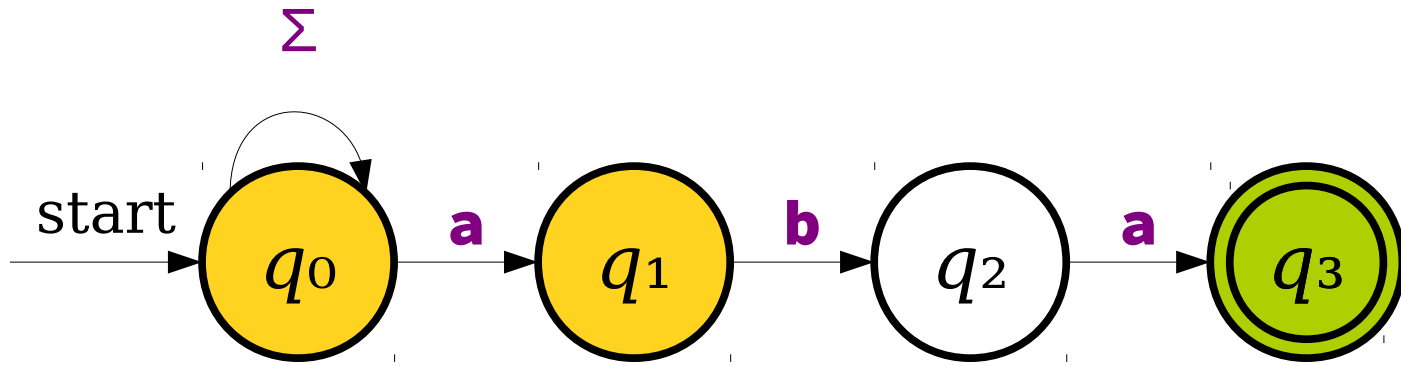

Massive Parallelism

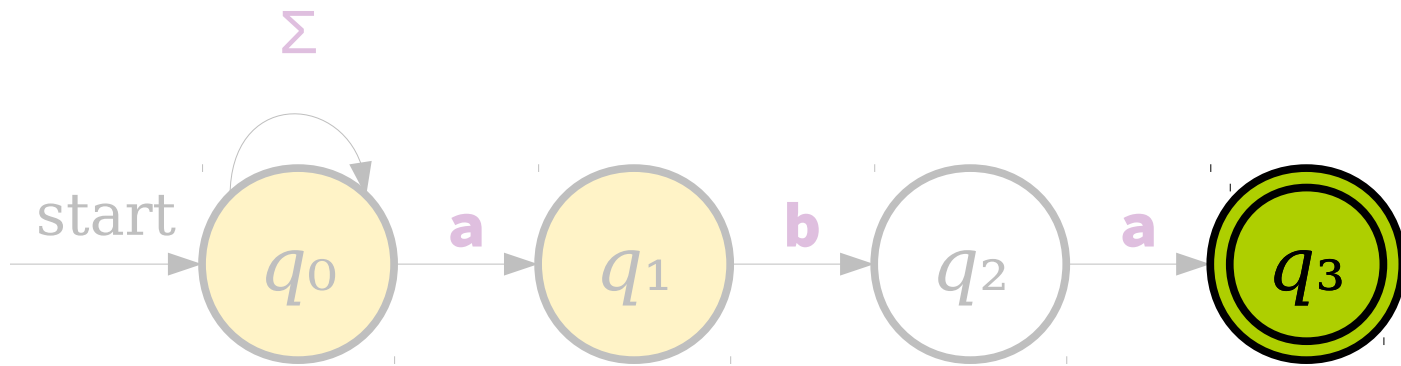

We're in at least one accepting state, so there's some path that gets us to an accepting state.

a	b	a	b	a
---	---	---	---	---



Massive Parallelism

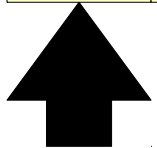
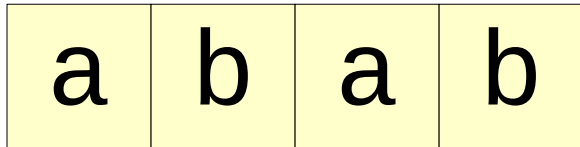
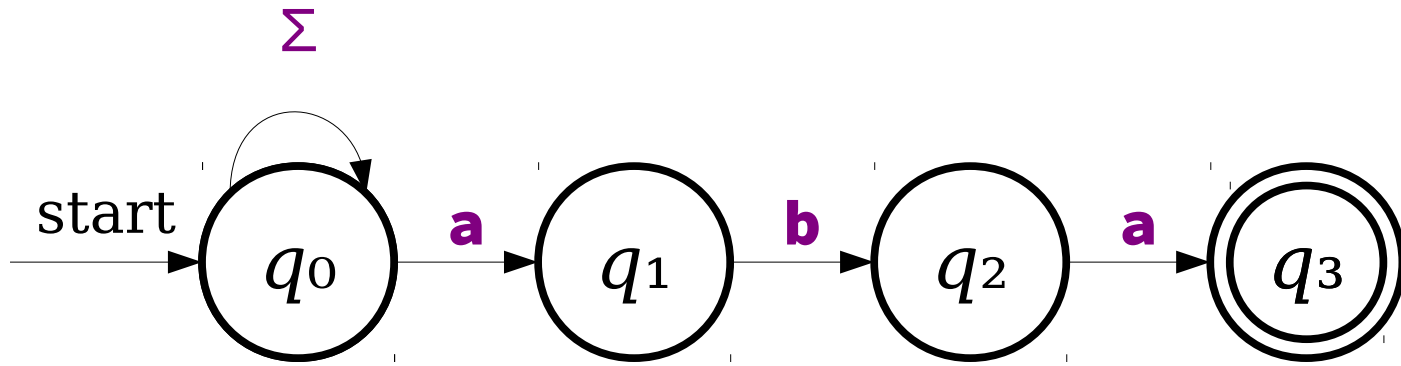

Massive Parallelism

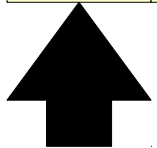
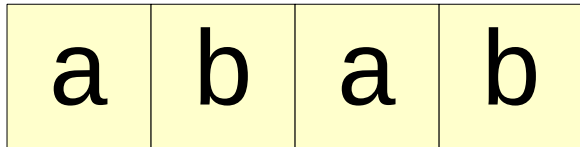
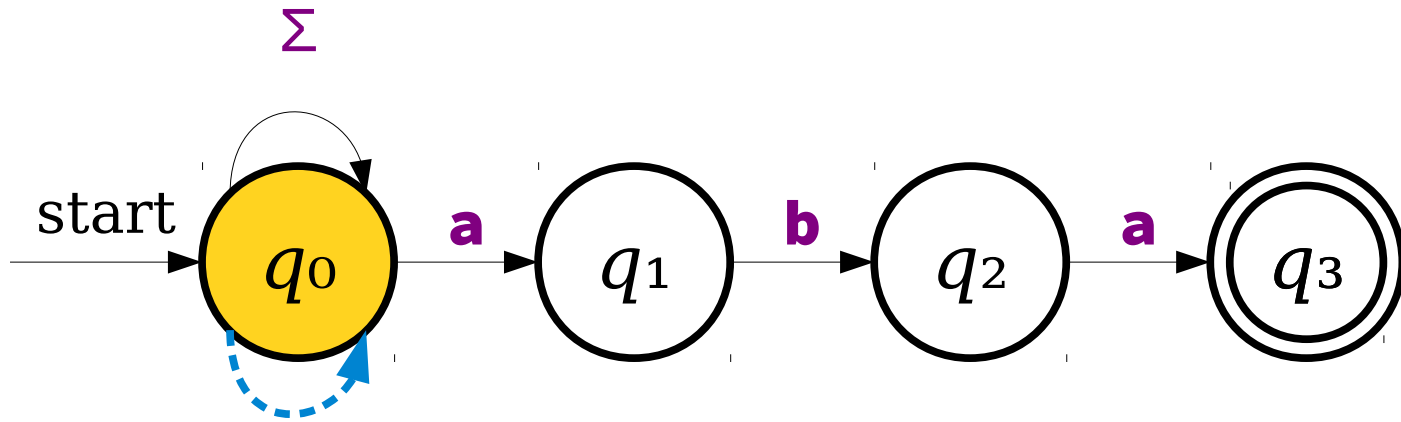

Massive Parallelism

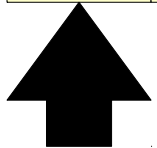
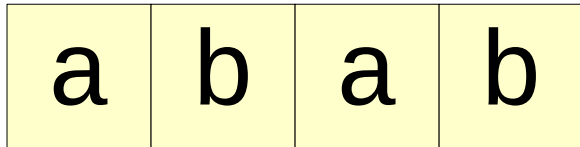
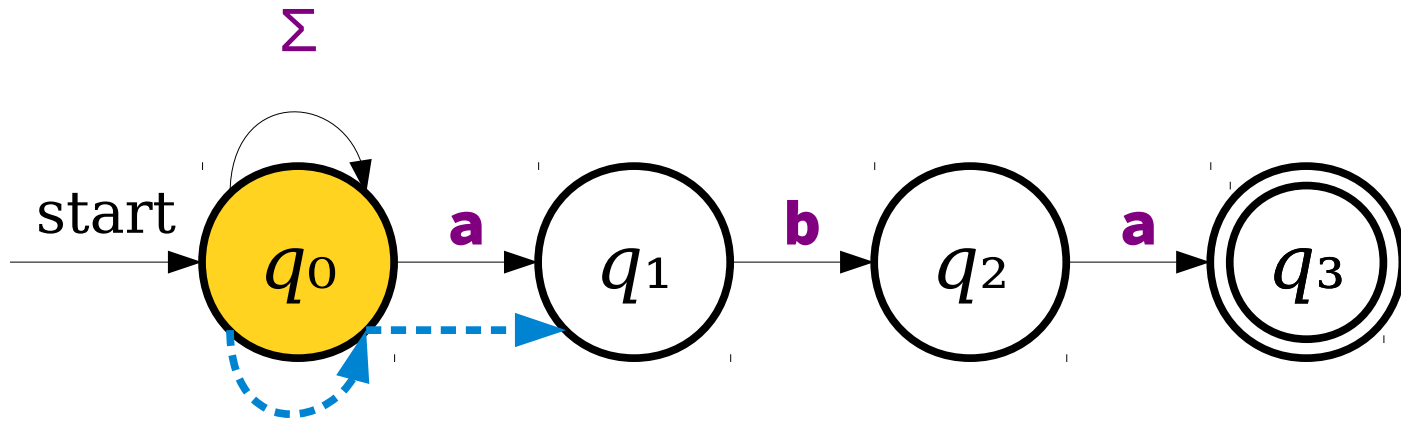

Massive Parallelism

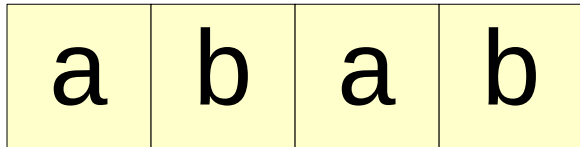
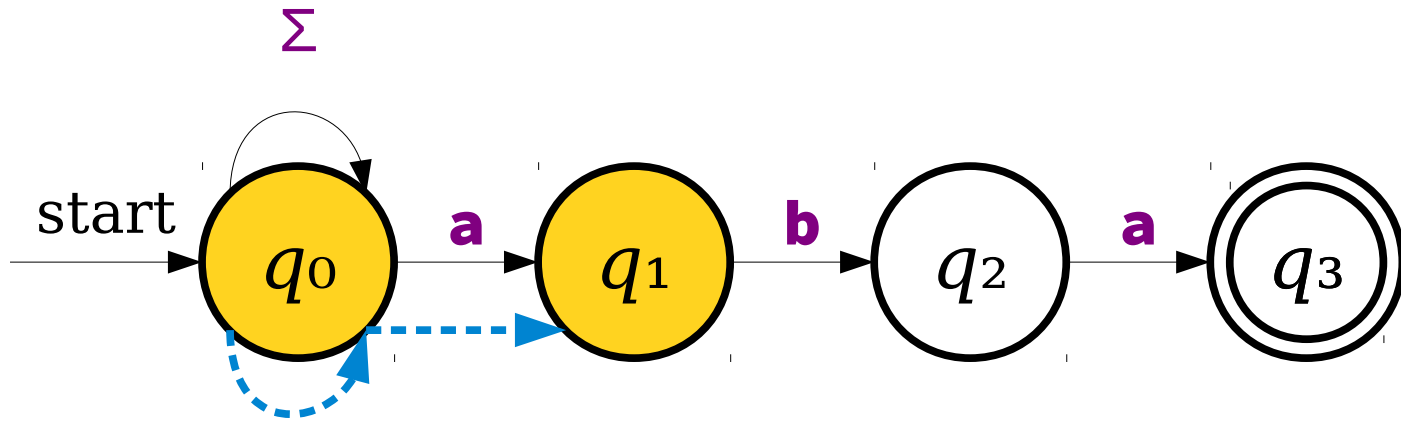

Massive Parallelism

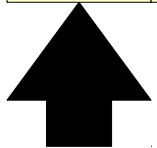
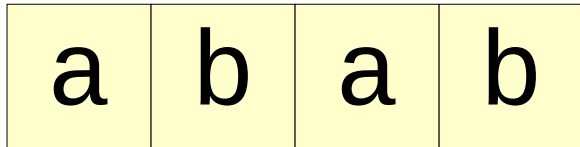
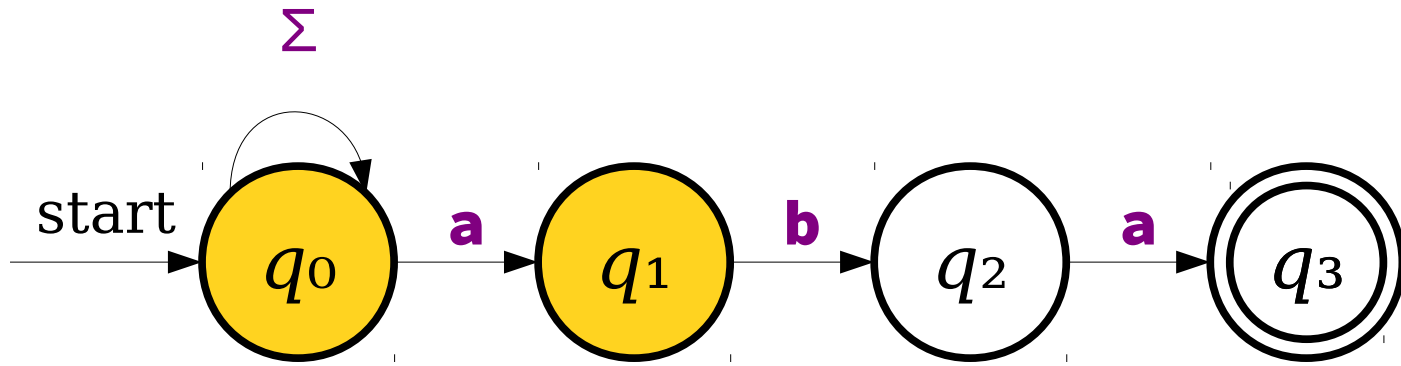

Massive Parallelism

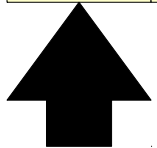
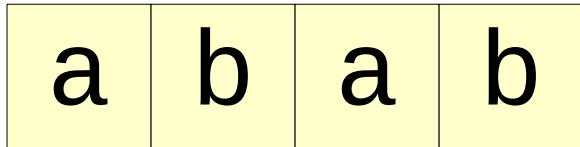
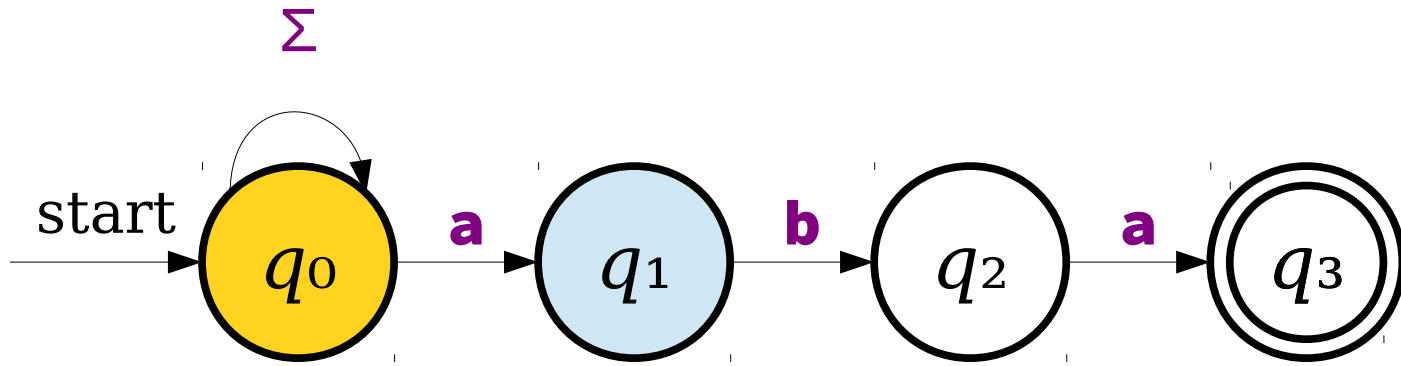

Massive Parallelism

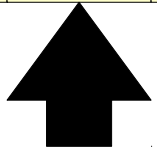
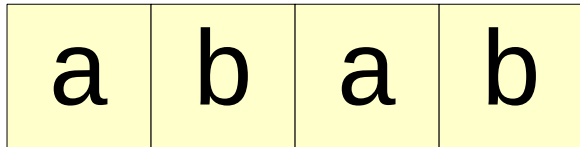
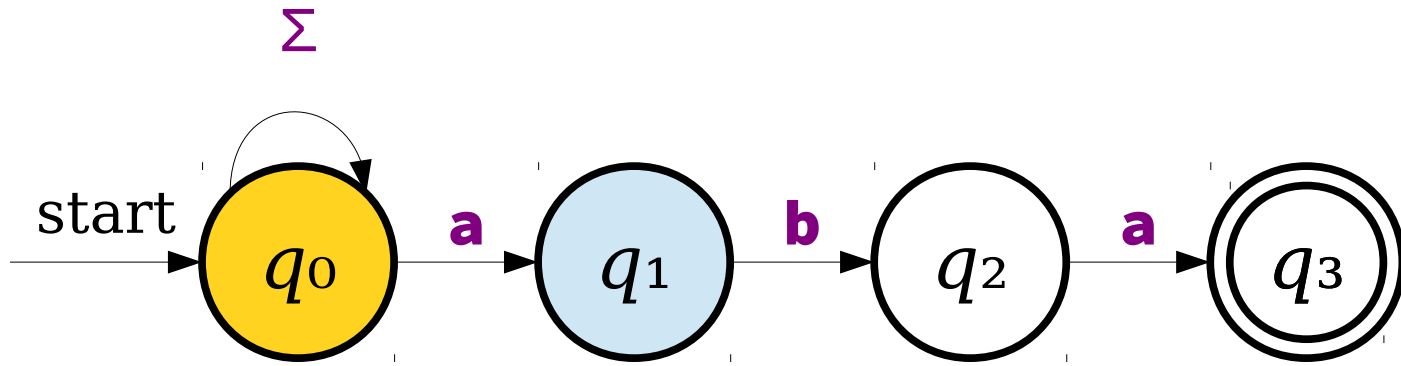

Massive Parallelism

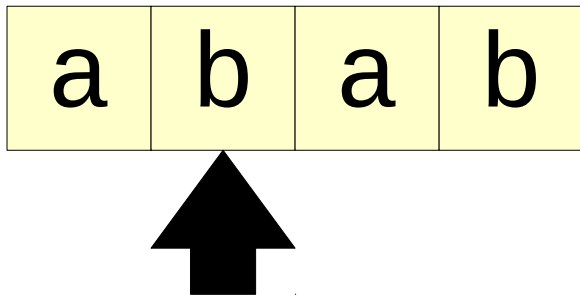
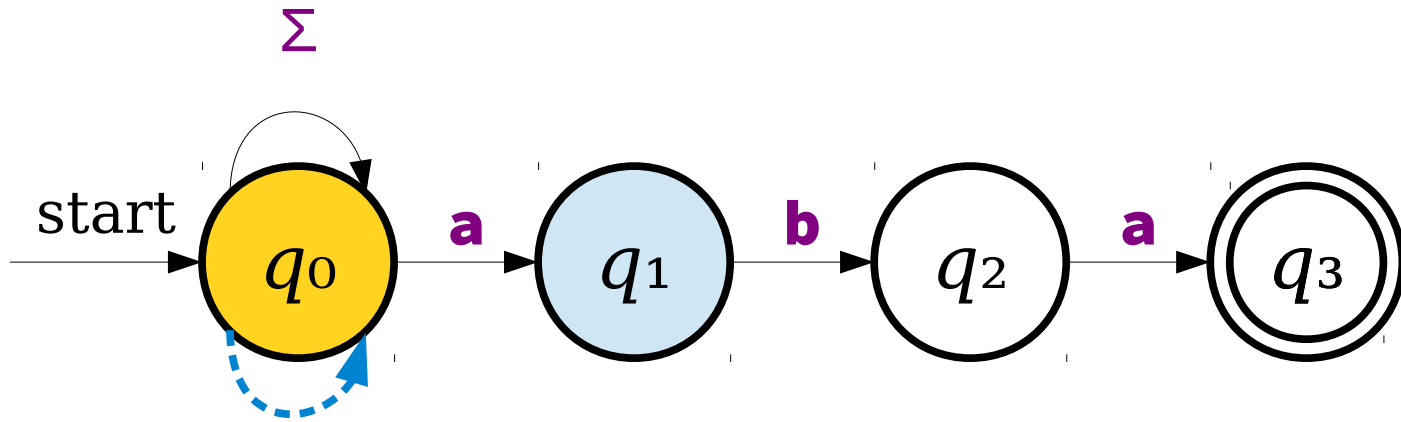

Massive Parallelism

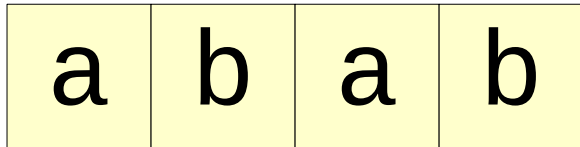
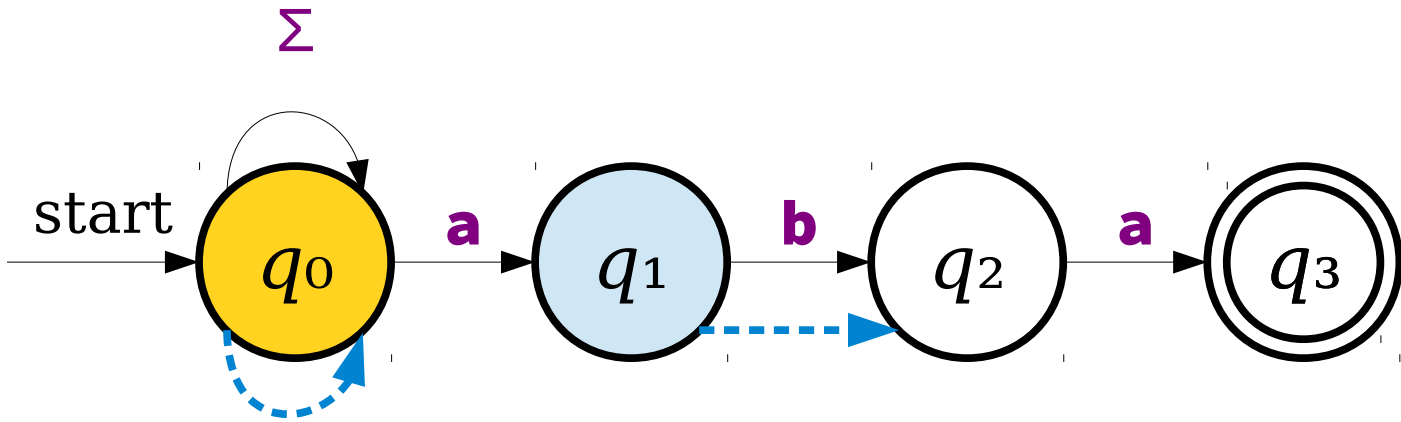

Massive Parallelism

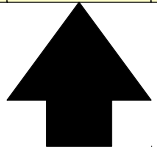
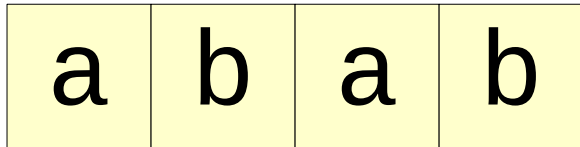
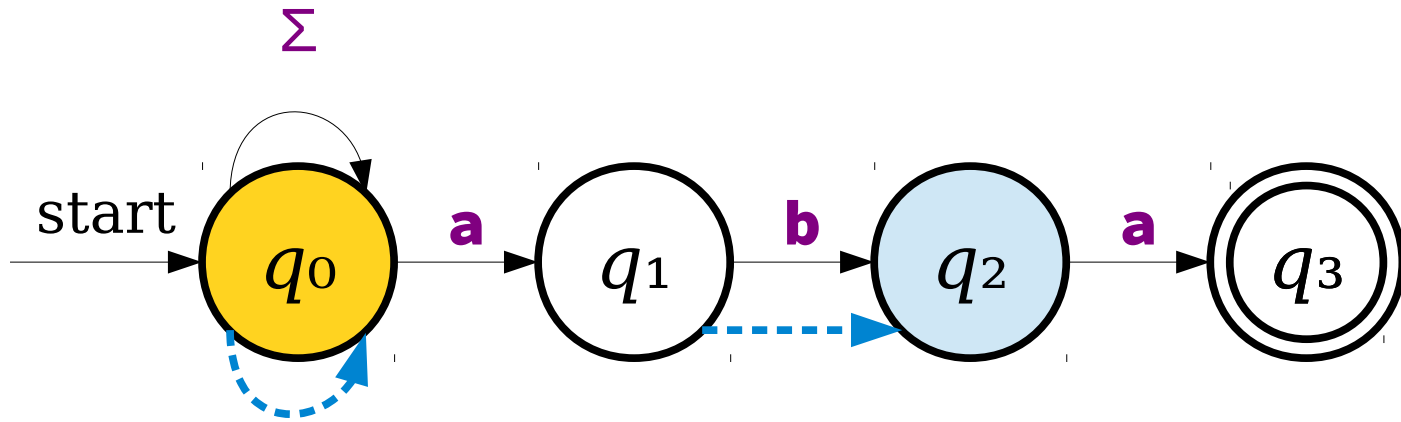

Massive Parallelism

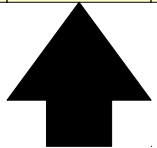
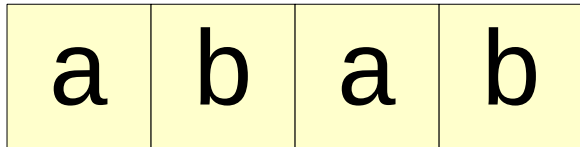
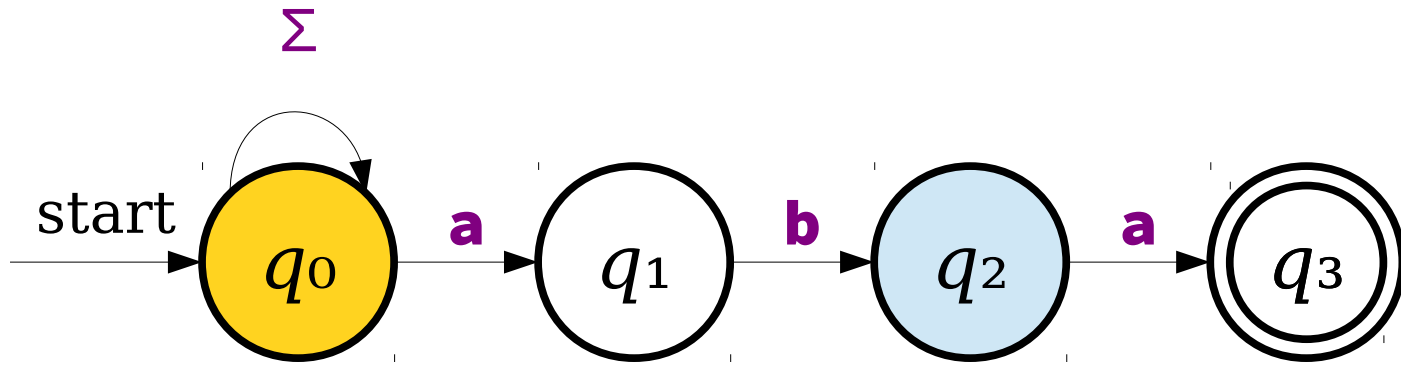

Massive Parallelism

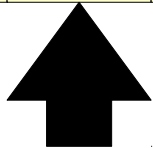
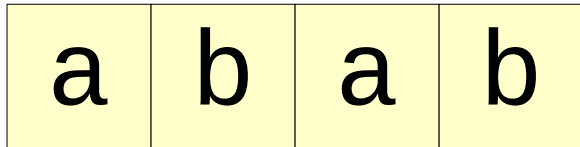
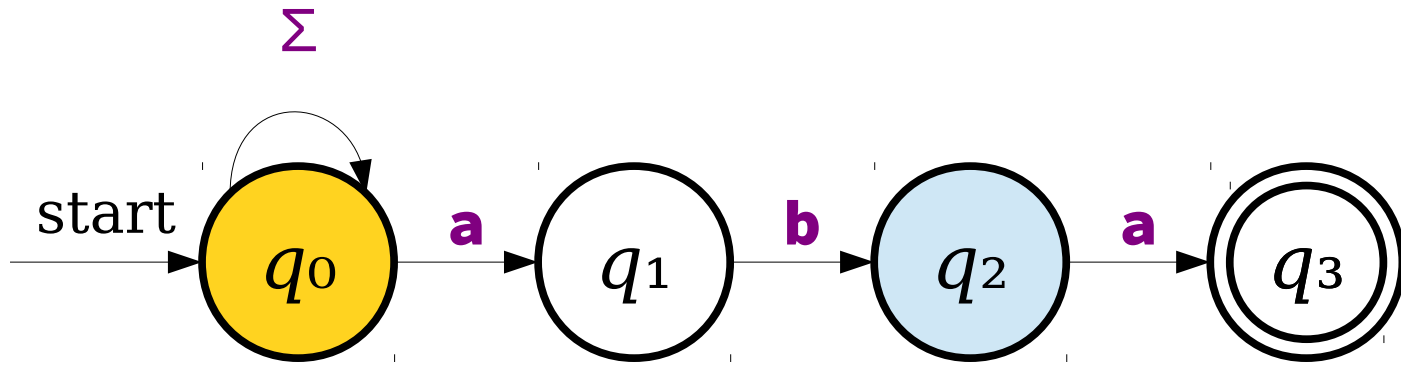

Massive Parallelism

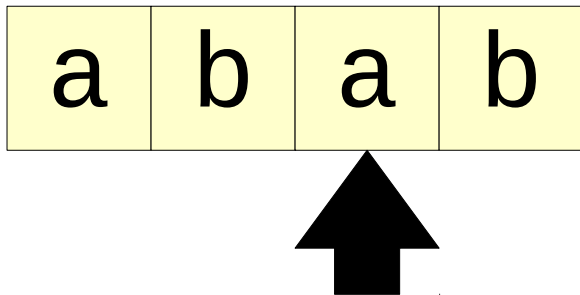
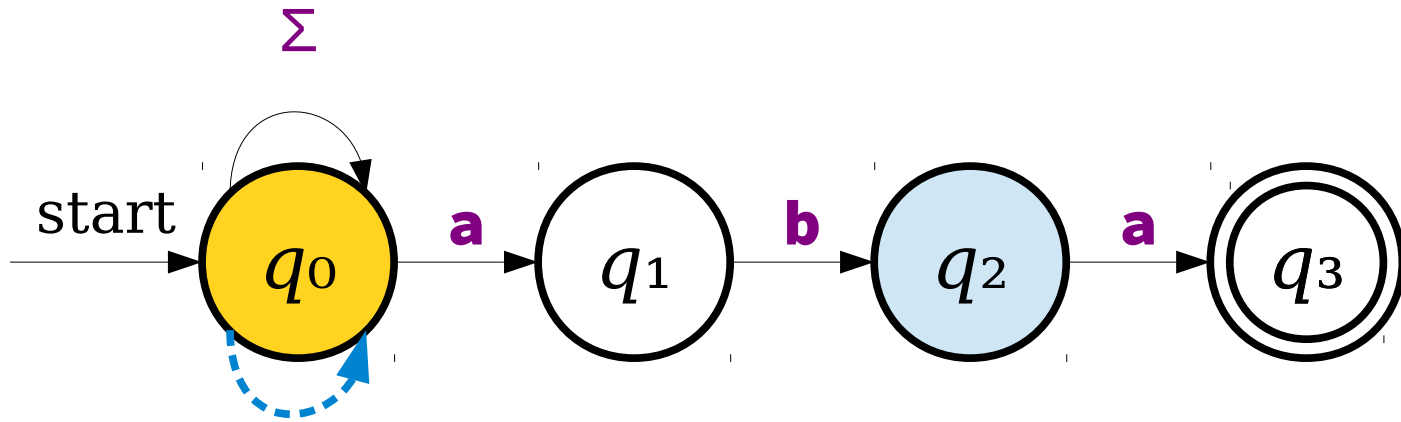

Massive Parallelism

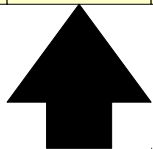
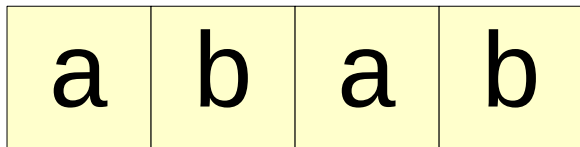
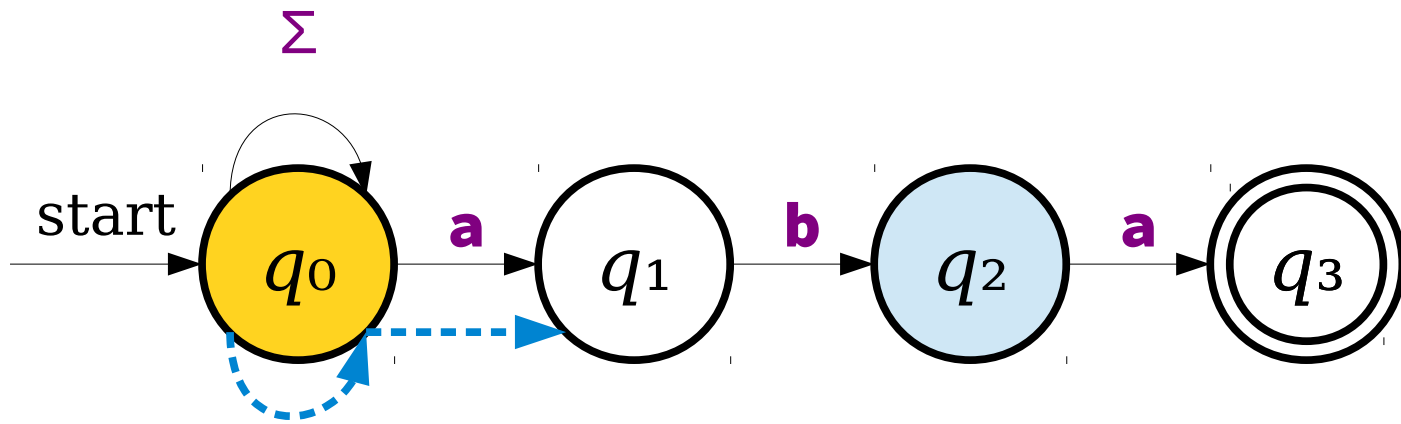

Massive Parallelism

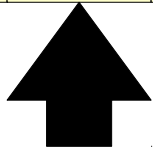
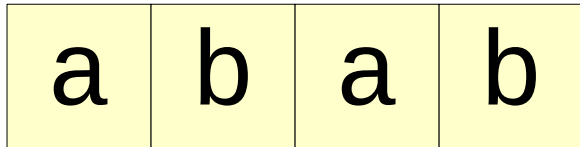
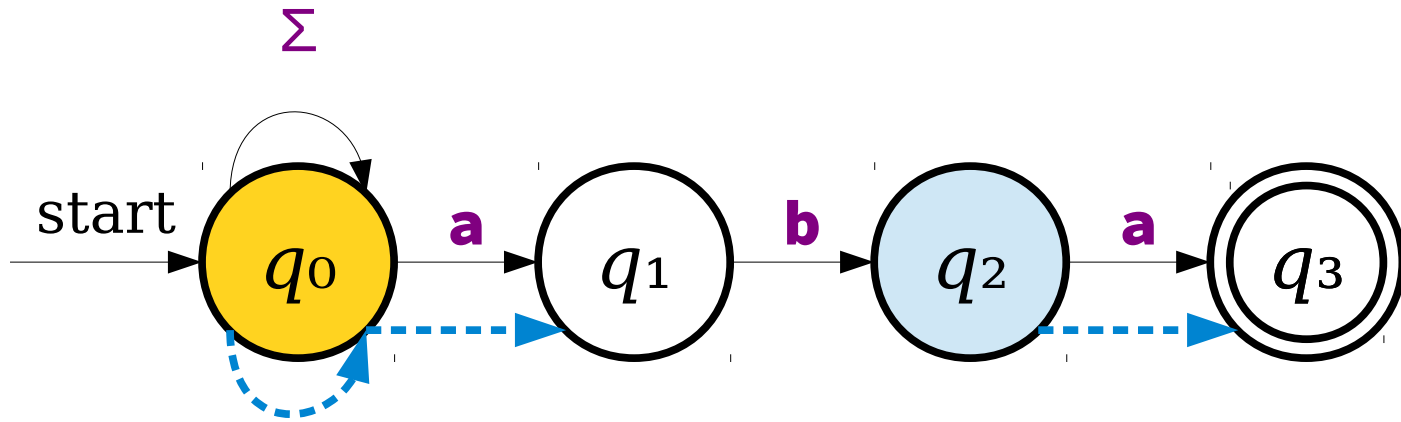

Massive Parallelism

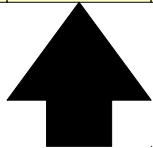
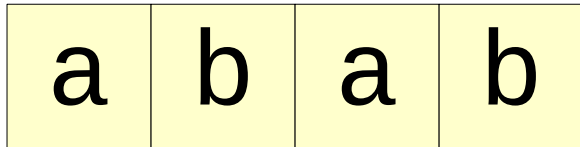
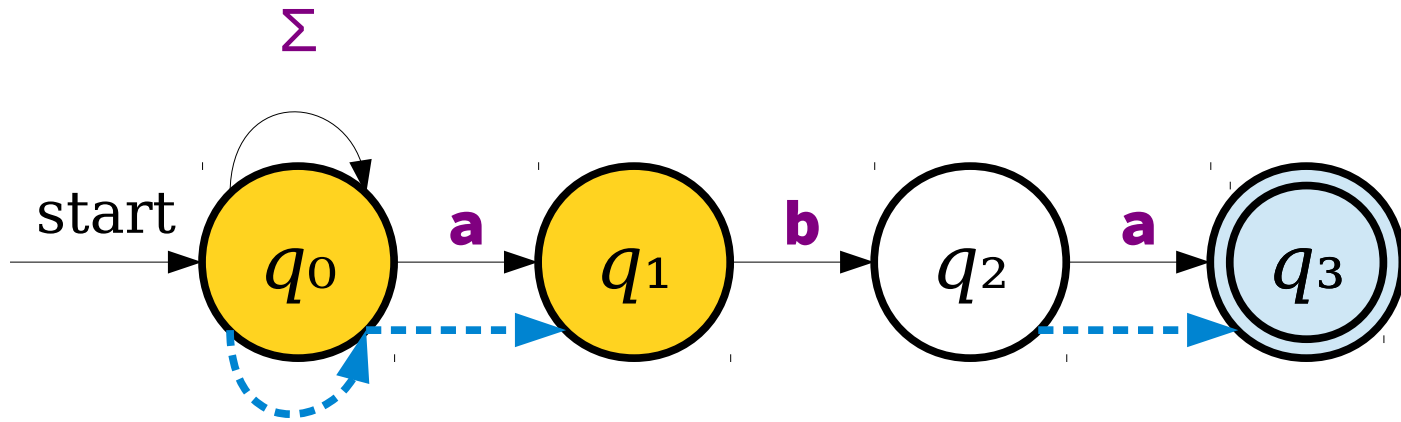

Massive Parallelism

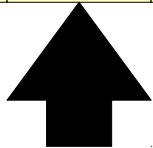
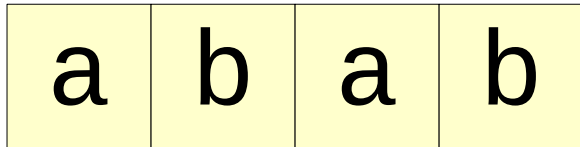
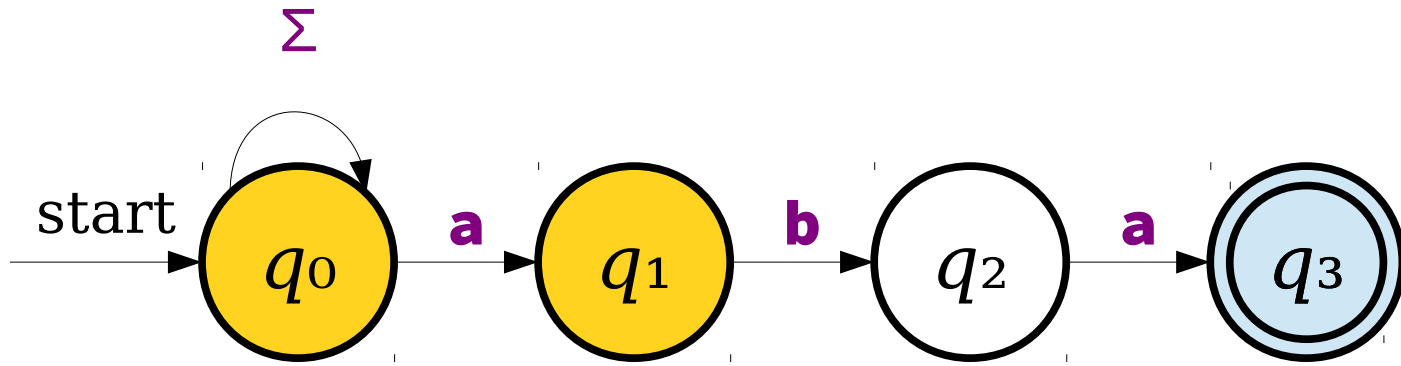

Massive Parallelism

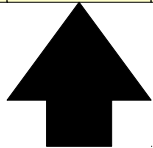
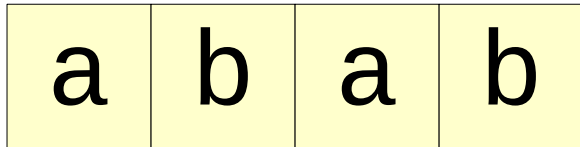
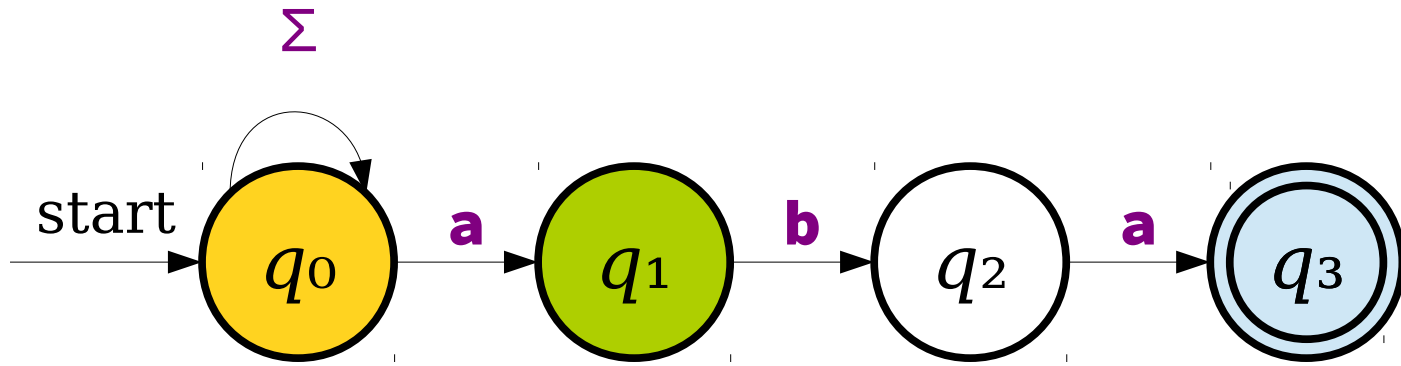

Massive Parallelism

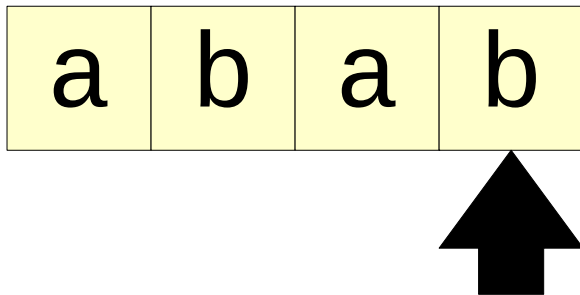
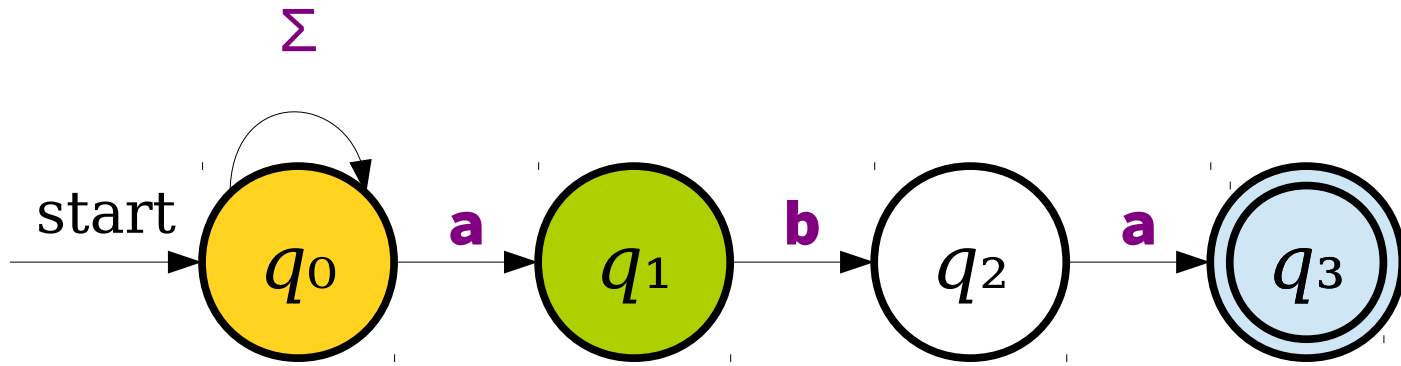

Massive Parallelism

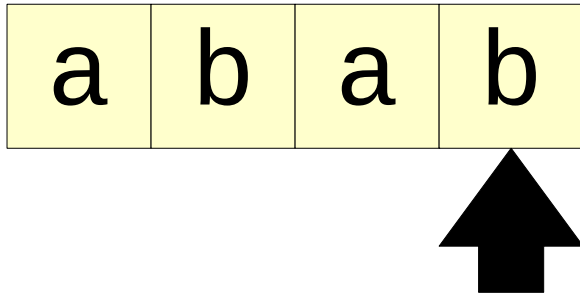
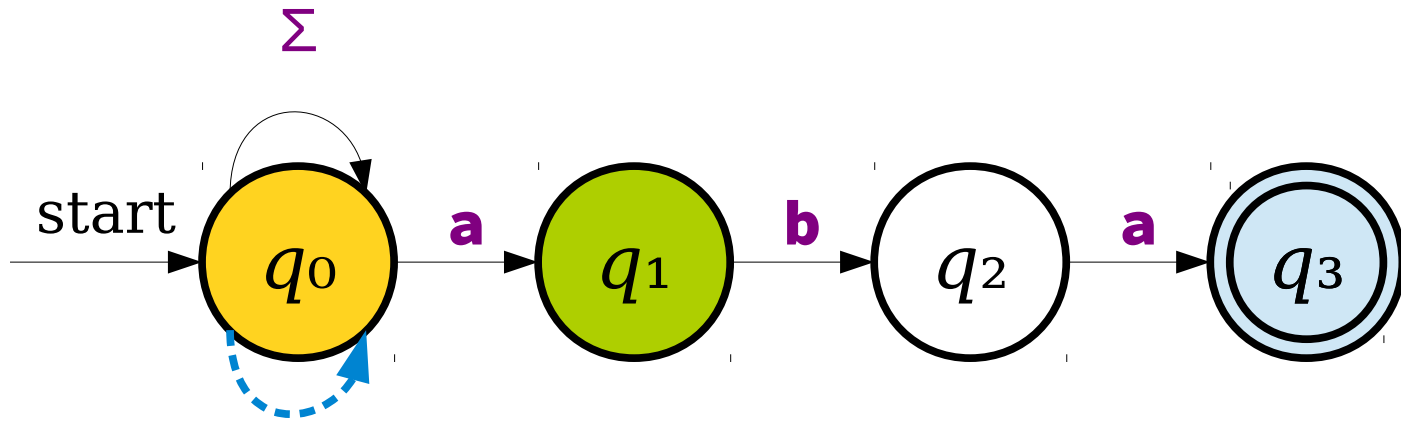

Massive Parallelism

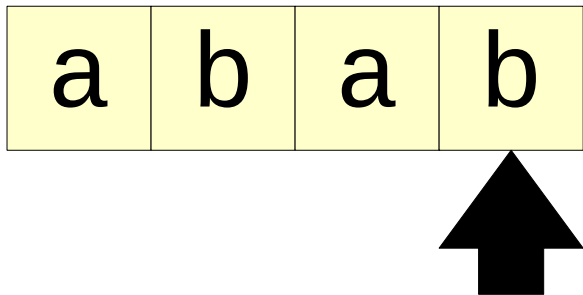
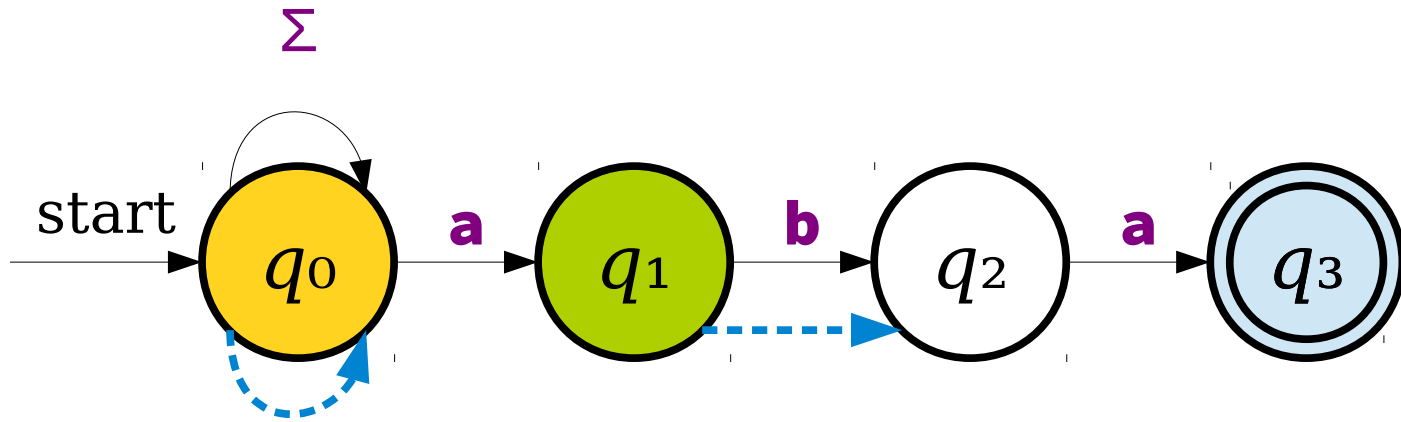

Massive Parallelism

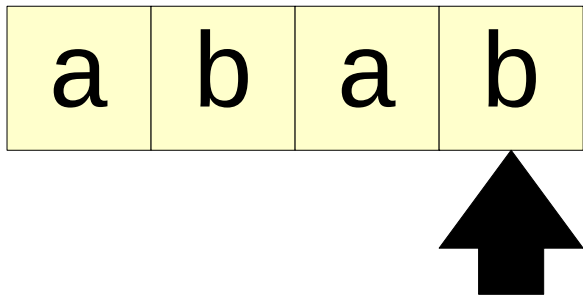
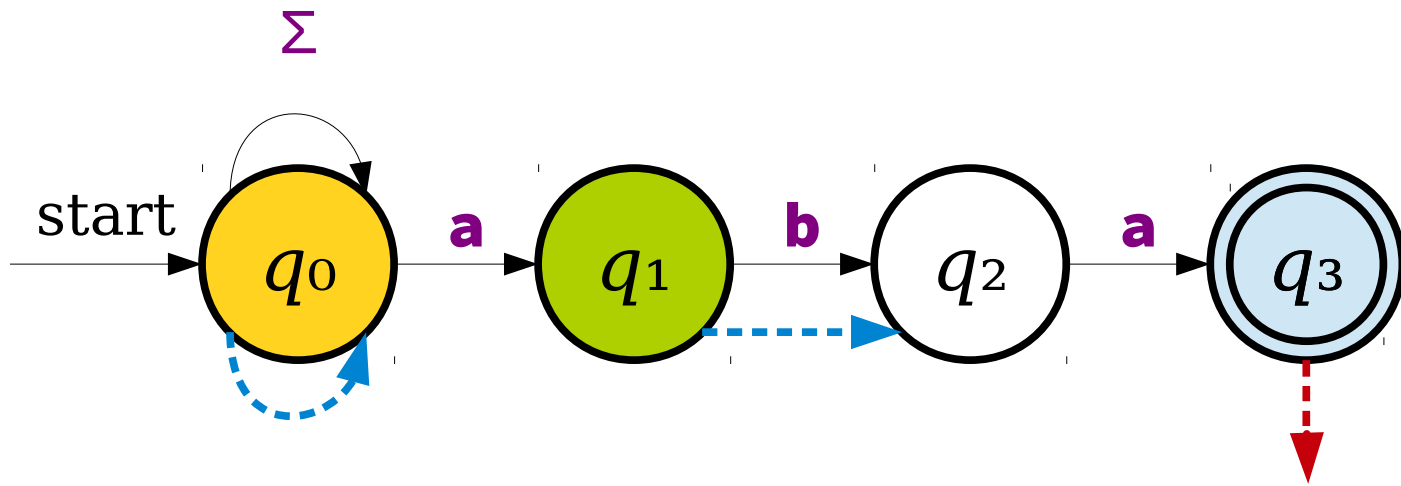

Massive Parallelism

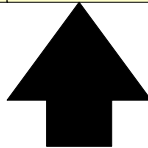
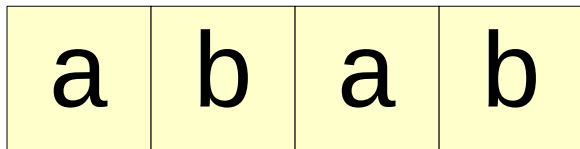
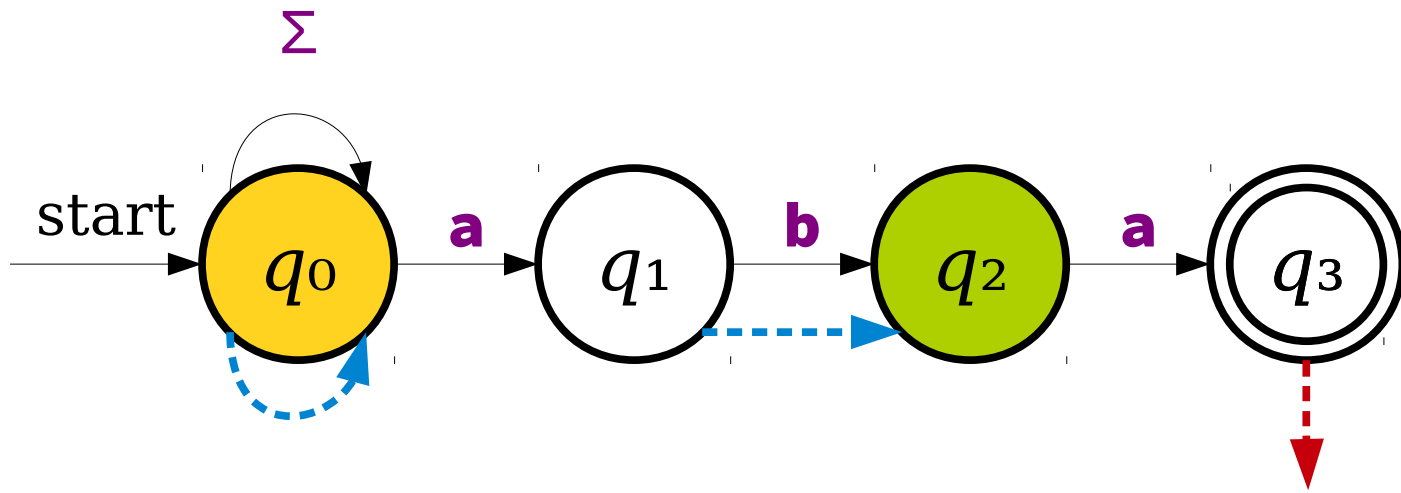

Massive Parallelism

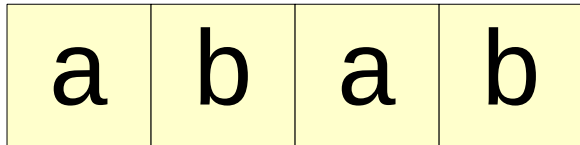
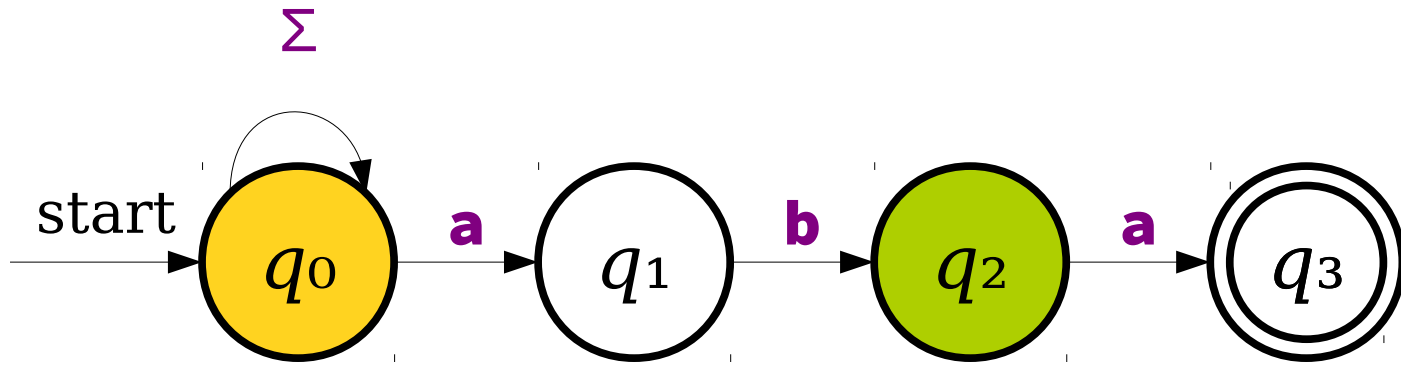

Massive Parallelism

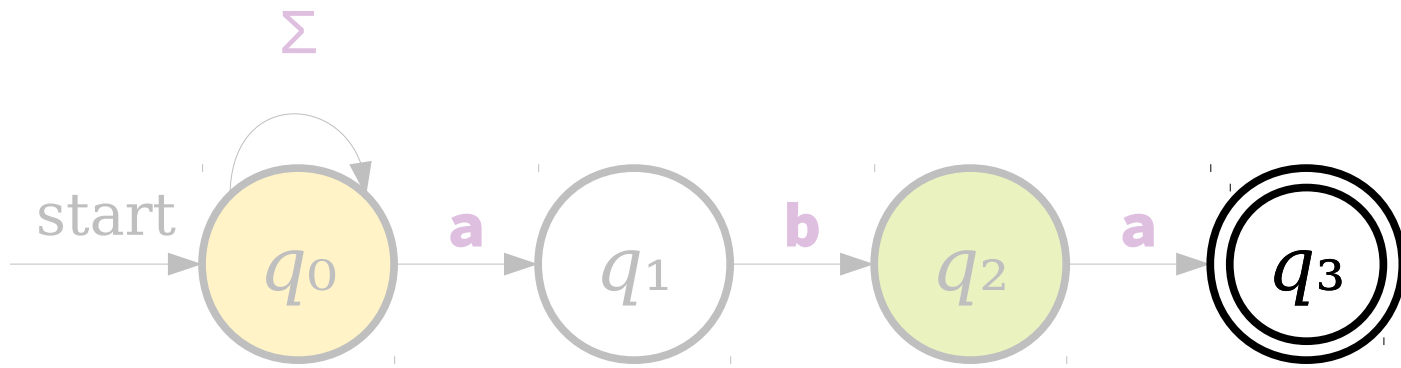

We're not in any accepting state, so no possible path accepts.

a	b	a	b
---	---	---	---



Massive Parallelism

- An NFA can be thought of as a DFA that can be in many states at once.
- At each point in time, when the NFA needs to follow a transition, it tries all the options at the same time.
- (Here's a rigorous explanation about how this works; read this on your own time).
 - Start off in the set of all states formed by taking the start state and including each state that can be reached by zero or more ϵ -transitions.
 - When you read a symbol **a** in a set of states S :
 - Form the set S' of states that can be reached by following a single **a** transition from some state in S .
 - Your new set of states is the set of states in S' , plus the states reachable from S' by following zero or more ϵ -transitions.

Designing NFAs

- ***Embrace the nondeterminism!***
- Good model: ***Guess-and-check:***
 - Is there some information that you'd really like to have? Have the machine *nondeterministically guess* that information.
 - Then, have the machine *deterministically check* that the choice was correct.

Guess-and-Check

$$L = \{ w \in \{0, 1\}^* \mid w \text{ ends in } 010 \text{ or } 101 \}$$

Guess-and-Check

$$L = \{ w \in \{0, 1\}^* \mid w \text{ ends in } 010 \text{ or } 101 \}$$

Ask yourself these design questions:

Would it be really easy to design an NFA to detect the substring 010 at the end, if you knew that's what you were looking for, and when you'd reached the near-end?

Would it be really easy to design an NFA to detect the substring 101, if you knew that's what you were looking for, and when you'd reached the near-end?

Would it be really convenient if you could just *magically guess* that?

Guess-and-Check

$$L = \{ w \in \{0, 1\}^* \mid w \text{ ends in } 010 \text{ or } 101 \}$$

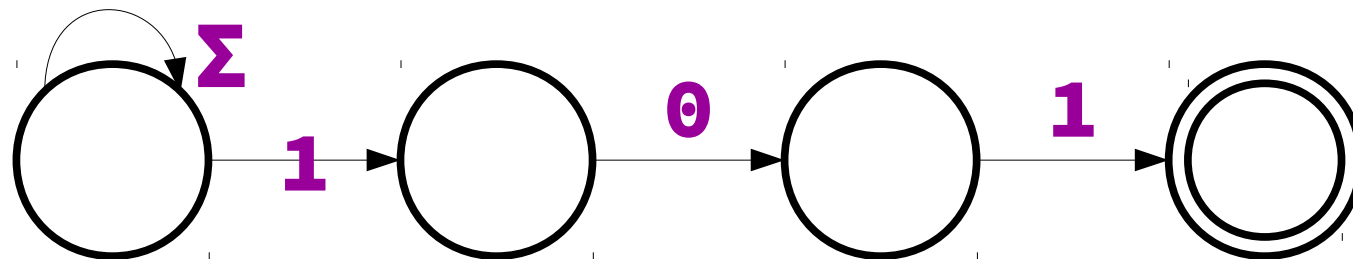
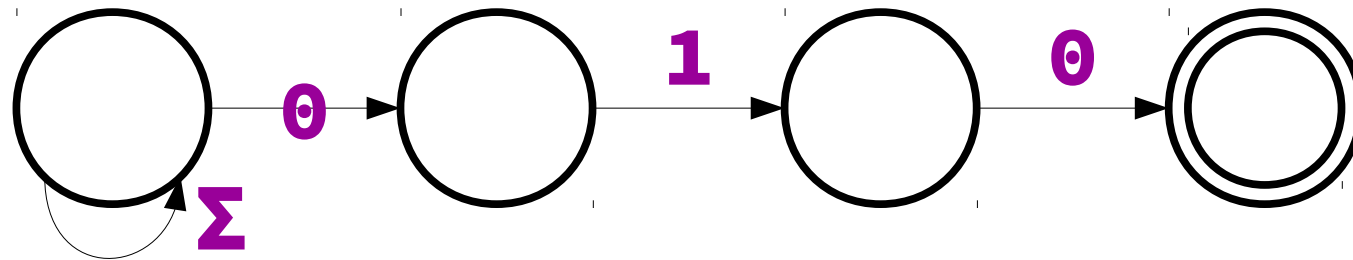

Guess-and-Check

$$L = \{ w \in \{0, 1\}^* \mid w \text{ ends in } 010 \text{ or } 101 \}$$

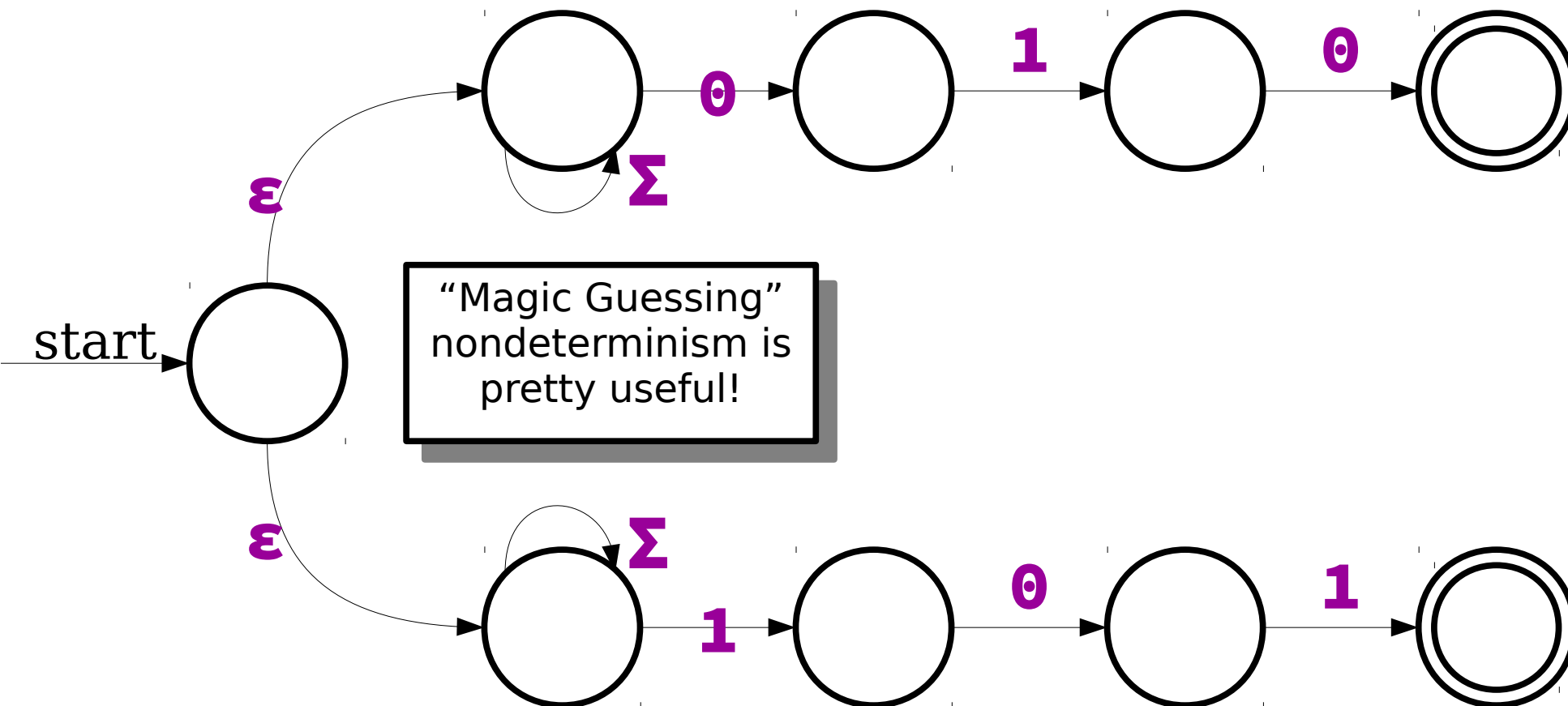

Guess-and-Check

$$L = \{ w \in \{0, 1\}^* \mid w \text{ ends in } 010 \text{ or } 101 \}$$
$$= L_1 \cup L_2 \text{ where:}$$

$$L_1 = \{ w \in \{0, 1\}^* \mid w \text{ ends in } 010 \}$$

$$L_2 = \{ w \in \{0, 1\}^* \mid w \text{ ends in } 101 \}$$

NFA Design Hack!

If you can write the language as the union of two or more very simple languages:

- (1) make simple DFA/NFAs for those simple languages
- (2) a single start state dispatches to the simple DFA/NFAs using epsilon transitions

Guess-and-Check

$$L = \{ w \in \{0, 1\}^* \mid w \text{ ends in } 010 \text{ or } 101 \}$$

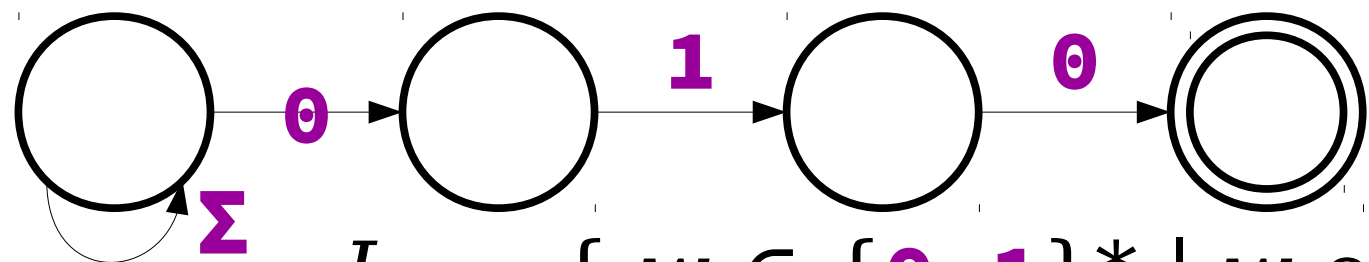

$$L_1 = \{ w \in \{0, 1\}^* \mid w \text{ ends in } 010 \}$$

$$L_2 = \{ w \in \{0, 1\}^* \mid w \text{ ends in } 101 \}$$

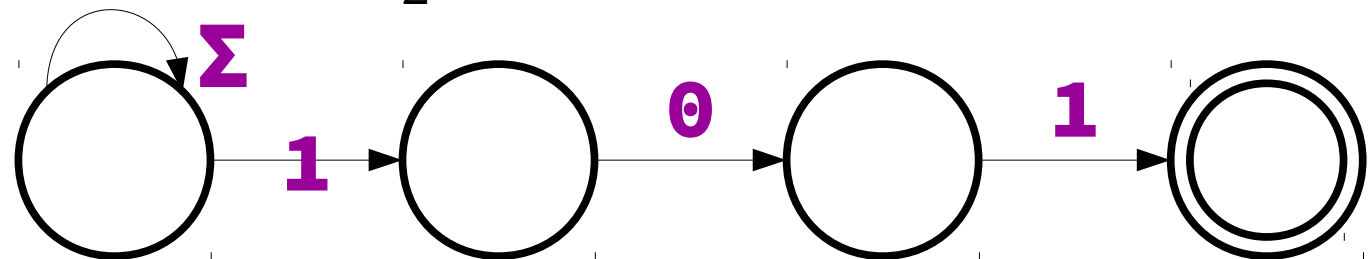

Guess-and-Check

$$L = \{ w \in \{0, 1\}^* \mid w \text{ ends in } 010 \text{ or } 101 \}$$

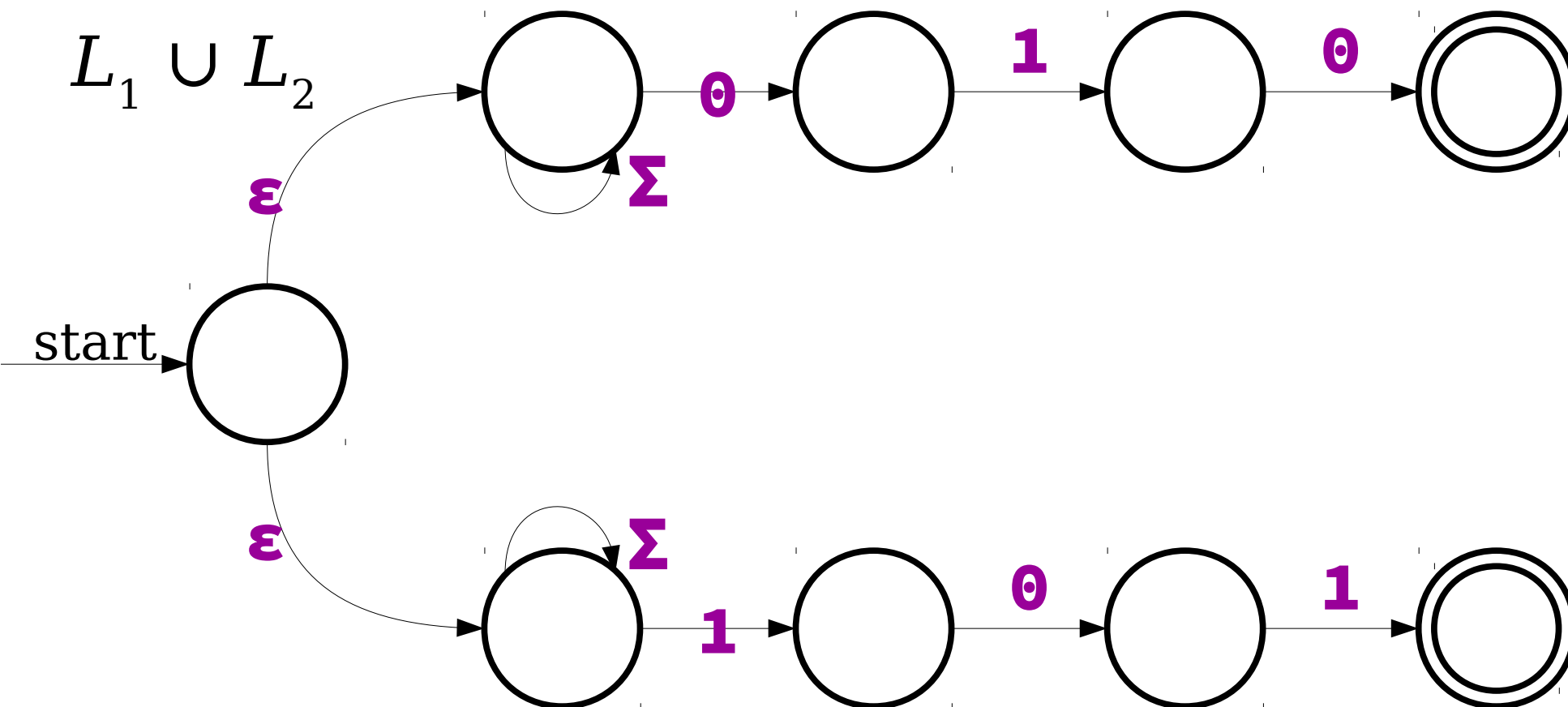

Guess-and-Check

$$L = \{ w \in \{0, 1\}^* \mid w \text{ ends in } 010 \text{ or } 101 \}$$

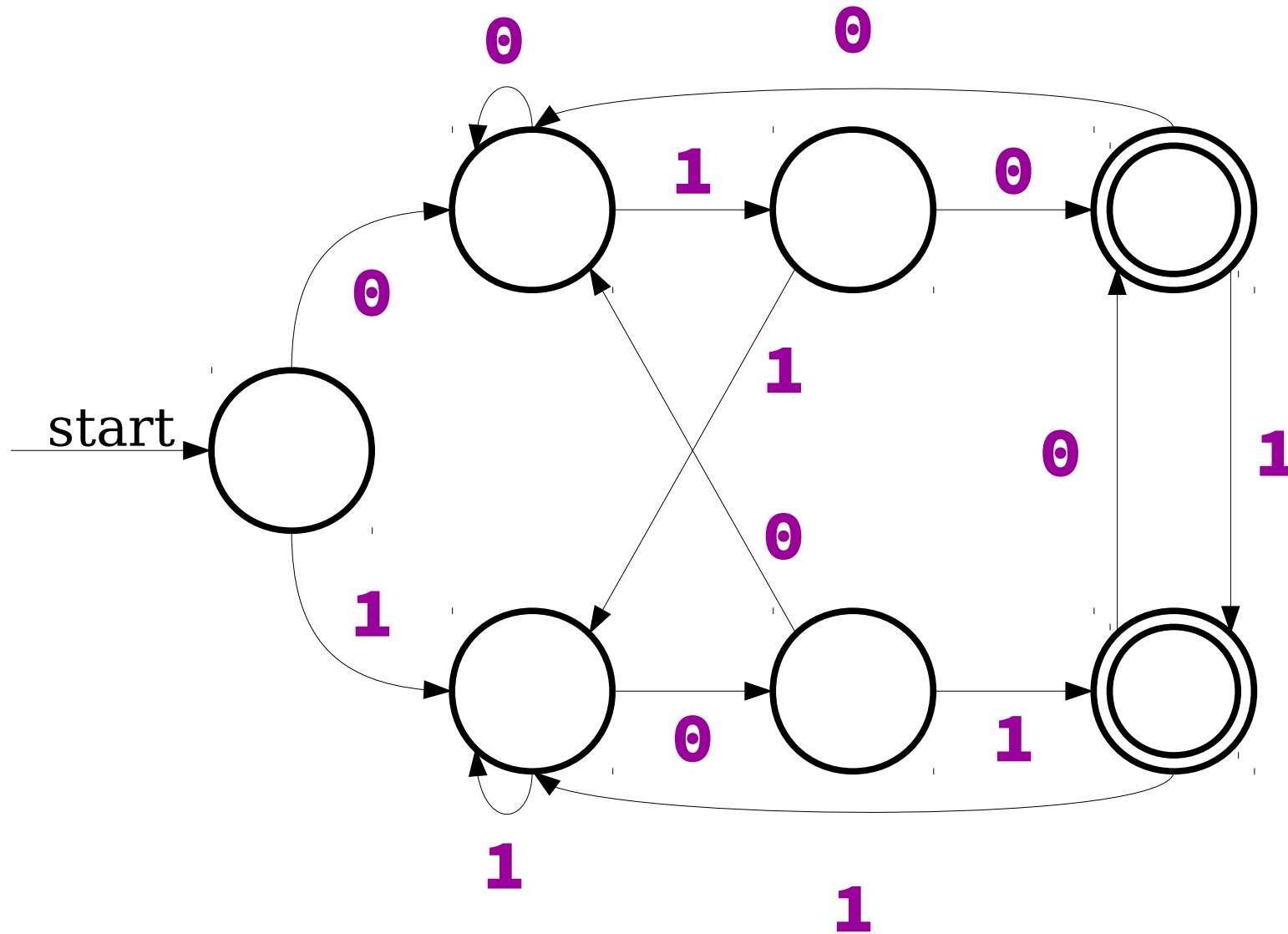

Guess-and-Check

$L = \{ w \in \{a, b, c\}^* \mid \text{at least one of } a, b, \text{ or } c \text{ is not in } w \}$

Guess-and-Check

$L = \{ w \in \{a, b, c\}^* \mid \text{at least one of } a, b, \text{ or } c \text{ is not in } w \}$

Ask yourself these design questions:

Would it be really easy to design an NFA to detect the string...

...has no a's in it, if you knew that's what you were looking for?

...has no b's in it, if you knew that's what you were looking for?

..has no c's in it, if you knew that's what you were looking for?

Would it be really convenient if you could just *magically guess* which letter is the missing one this time?

Guess-and-Check

$L = \{ w \in \{a, b, c\}^* \mid \text{at least one of } a, b, \text{ or } c \text{ is not in } w \}$

$L_1 = \{ w \in \{a, b, c\}^* \mid a \text{ is not in } w \}$

$L_2 = \{ w \in \{a, b, c\}^* \mid b \text{ is not in } w \}$

$L_3 = \{ w \in \{a, b, c\}^* \mid c \text{ is not in } w \}$

$L = L_1 \cup L_2 \cup L_3$

Ask yourself these design questions:

Would it be really easy to design an NFA to detect the string...

...has no a's in it, if you knew that's what you were looking for?

...has no b's in it, if you knew that's what you were looking for?

..has no c's in it, if you knew that's what you were looking for?

Would it be really convenient if you could just **magically guess** which letter is the missing one this time?

Guess-and-Check

$$L = \{ w \in \{a, b, c\}^* \mid \text{at least one of } a, b, \text{ or } c \text{ is not in } w \} = L_1 \cup L_2 \cup L_3$$

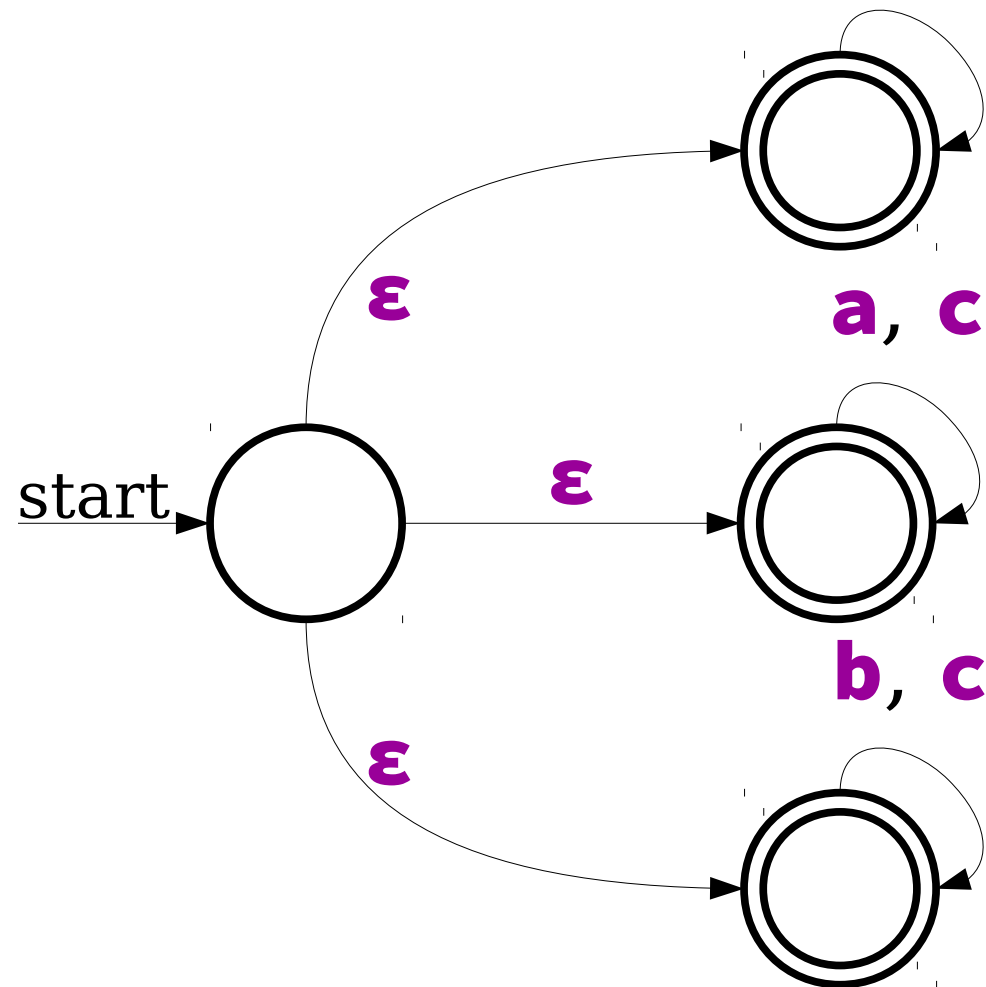

$$L_3 = \{ w \in \{a, b, c\}^* \mid c \text{ is not in } w \}$$

$$L_2 = \{ w \in \{a, b, c\}^* \mid b \text{ is not in } w \}$$

$$L_1 = \{ w \in \{a, b, c\}^* \mid a \text{ is not in } w \}$$

Just how powerful are NFAs?

Next Time

- ***The Powerset Construction***
 - So beautiful. So elegant. So cool!
- ***More Closure Properties***
 - Other set-theoretic operations.
- ***Language Transformations***
 - What's the deal with the notation Σ^* ?